

RFD40

RFID Standard Sled



ZEBRA

Product Reference Guide

ZEBRA and the stylized Zebra head are trademarks of Zebra Technologies Corporation, registered in many jurisdictions worldwide. All other trademarks are the property of their respective owners.
© 2021 Zebra Technologies Corporation and/or its affiliates. All rights reserved.

Information in this document is subject to change without notice. The software described in this document is furnished under a license agreement or nondisclosure agreement. The software may be used or copied only in accordance with the terms of those agreements.

For further information regarding legal and proprietary statements, please go to:

SOFTWARE: zebra.com/linkoslegal

COPYRIGHTS: zebra.com/copyright

WARRANTY: zebra.com/warranty

END USER LICENSE AGREEMENT: zebra.com/eula

Terms of Use

Proprietary Statement

This manual contains proprietary information of Zebra Technologies Corporation and its subsidiaries (“Zebra Technologies”). It is intended solely for the information and use of parties operating and maintaining the equipment described herein. Such proprietary information may not be used, reproduced, or disclosed to any other parties for any other purpose without the express, written permission of Zebra Technologies.

Product Improvements

Continuous improvement of products is a policy of Zebra Technologies. All specifications and designs are subject to change without notice.

Liability Disclaimer

Zebra Technologies takes steps to ensure that its published Engineering specifications and manuals are correct; however, errors do occur. Zebra Technologies reserves the right to correct any such errors and disclaims liability resulting therefrom.

Limitation of Liability

In no event shall Zebra Technologies or anyone else involved in the creation, production, or delivery of the accompanying product (including hardware and software) be liable for any damages whatsoever (including, without limitation, consequential damages including loss of business profits, business interruption, or loss of business information) arising out of the use of, the results of use of, or inability to use such product, even if Zebra Technologies has been advised of the possibility of such damages. Some jurisdictions do not allow the exclusion or limitation of incidental or consequential damages, so the above limitation or exclusion may not apply to you.

Contents

Getting Started

Unpacking	6
Setting up the RFD40 RFID Standard Sled	6
Features	7
Adaptor Installation	8
Installing the Mobile Computer into the Sled	9
Removing the Mobile Computer from the Sled	9
Sled Battery Replacement	10
Battery Installation	10
Battery Removal	10
Charging	11
UI Indicators	12
Decode LED Definitions	12
Battery LED Definitions	12
Battery Beeper Indications	12
Trigger Modes	13

123RFID Mobile

Requirements	14
Installing 123RFID Mobile	14
Using 123RFID Mobile	14
Readers List	15
Rapid Read	18
Locate Tag	21
Settings	31
RFID Settings	33
Application Settings	43

123RFID Desktop Application

123RFID Desktop Features	44
Connect	45
Read	46
Reader Configuration	47
Reader Name	48

General Parameter Settings	48
Region Configuration	49
Antenna Configuration	50
Trigger Configuration	51
Pre-Filter Configuration	52
Advanced Configuration Settings	53
Save and Print Configuration	54
Firmware Management	55
Maintenance and Technical Specifications	
Maintenance	57
Known Harmful Ingredients	57
Approved Cleaners	58
Cleaning the Sled	58
Technical Specifications	59
Troubleshooting	
Troubleshooting	60

About This Guide

The table below describes the configuration of the RFD40 RFID Standard sled.

Table 1 RFD40 RFID Standard Sled Configurations

SKU	Description
RFD4030	RFD40, Standard, Standard Range Circular Polarized Antenna, UHF RFID Only, Gun, No Imager, 7000mAh Battery, Midnight Black

Service Information

If you have a problem using the equipment, contact your facility's technical or systems support. If there is a problem with the equipment, they will contact the Zebra Global Customer Support Center at: zebra.com/support.

When contacting Zebra support, please have the following information available:

- Serial number of the unit
- Model number or product name
- Software type and version number

Zebra responds to calls by e-mail, telephone or fax within the time limits set forth in support agreements.

If your problem cannot be solved by Zebra support, you may need to return your equipment for servicing and will be given specific directions. Zebra is not responsible for any damages incurred during shipment if the approved shipping container is not used. Shipping the units improperly can possibly void the warranty.

If you purchased your business product from a Zebra business partner, contact that business partner for support.

Getting Started

Unpacking

This chapter provides information on RFD40 RFID Standard sled parts, battery installation, mobile device attachment, LED indications, and charging. Carefully remove all protective material from the RFD40 RFID Standard sled and save the shipping container for later storage and shipping.

Verify the following items are in the box:

- RFD40 RFID Standard sled
- Battery
- Lanyard
- Quick Start Guide

Inspect the equipment for damage. If any equipment is missing or damaged, contact the Zebra Support Center immediately.

For a full list of accessories that can be used with the RFD40 RFID Standard sled, refer to the product specific Technical Accessory Guide available at: zebra.com/support.

Setting up the RFD40 RFID Standard Sled

The RFD40 UHF RFID Standard sled provides RAIN Radio Frequency Identification (RFID) tag reading, writing, and locating capability to supported Zebra mobile computers.

To use the sled for the first time with a mobile computer:

1. Insert the battery into the sled
2. Charge the sled in the charging cradle, charging cup, or by USB-C cable.
3. Replace the standard cover that comes with the sled with the adaptor that is specific to the mobile computer being used with the sled.
4. Place the mobile computer into the adaptor headfirst.
5. Attach the mobile computer on the sled.
6. Set the region using 123RFID Desktop or 123RFID Mobile.

For the latest versions of guides and software, go to: zebra.com/support.

For detailed information, refer to the Product Reference Guide at: zebra.com/support.

Features

The RFD40 RFID Standard sled adds a RFID gun-style handle with a scanning trigger to the mobile computer or Windows PC. Used for all RFID operations, the sled increases comfort when using the mobile computer in scan-intensive applications for extended periods of time.

Figure 1 RFD40 RFID Standard Sled Features

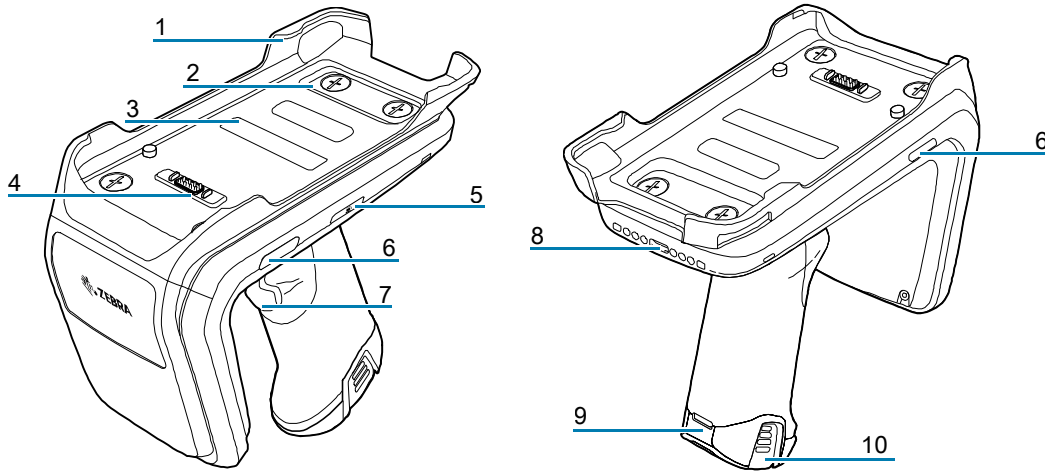

1	Adaptor (Sold Separately)
2	Coin Screws (4)
3	Adaptor Label
4	eConnex™ Communication Port
5	Battery Status LED
6	Decode LED
7	Tri-Function Trigger
8	Charging Contact and USB-C Port
9	Tethering Point for Handstrap
10	Rubber Foot

Adaptor Installation

To install the adaptor,

1. Remove the cover by pulling up on the lip.
2. Secure the adaptor onto the sled by fastening the four coin screws into the sled.

Figure 2 Adaptor Installation

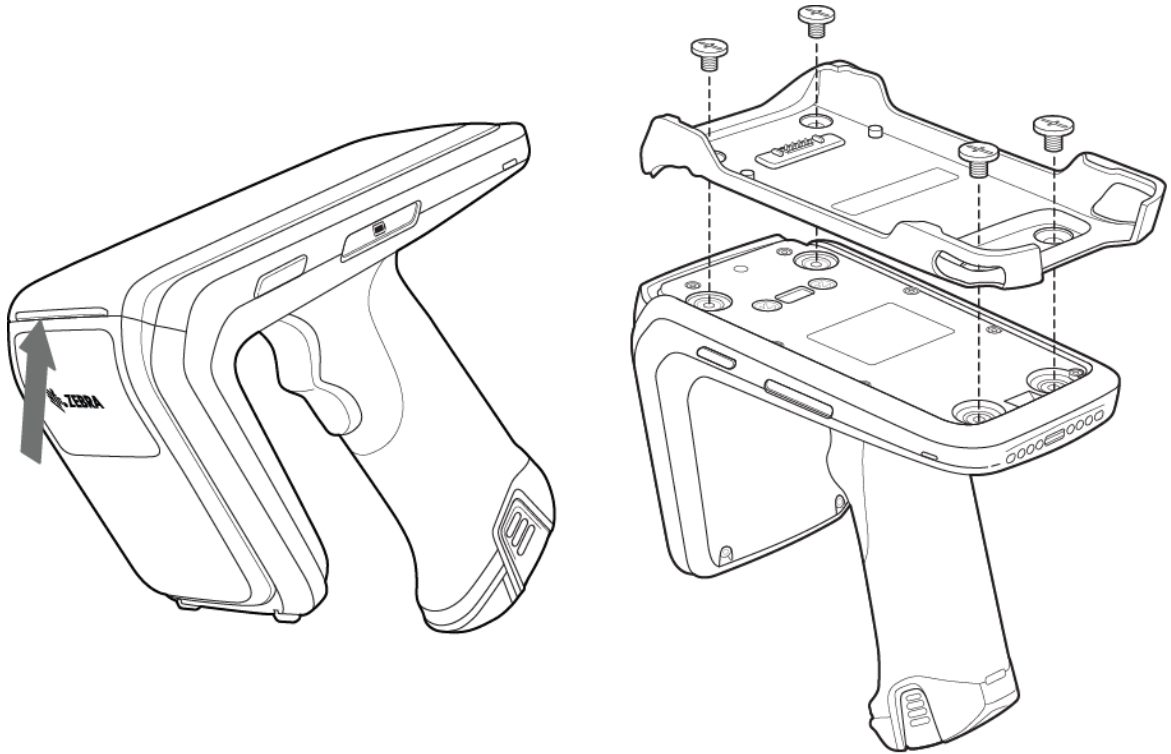

Installing the Mobile Computer into the Sled

To secure the mobile computer to the RFD40 Standard RFID sled, place the top of the device fully forward into the sled adaptor and push down on the bottom of the mobile computer.



NOTE: Depending on the mobile computer being used with the sled, the mobile computer may be inserted into the adaptor tail-end first.



NOTE: While installing the mobile computer into the adaptor, use caution and do not collide with the eConnex™ communication port pins on the RFD40.

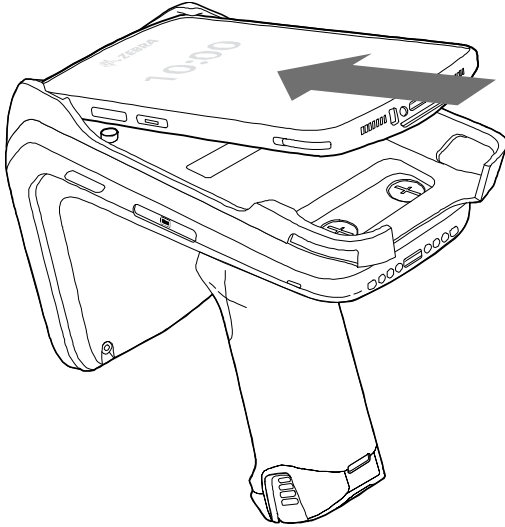

Removing the Mobile Computer from the Sled

To remove the mobile computer from the RFD40 Standard RFID sled, firmly hold the sled handle, and lift the device off of the sled base.

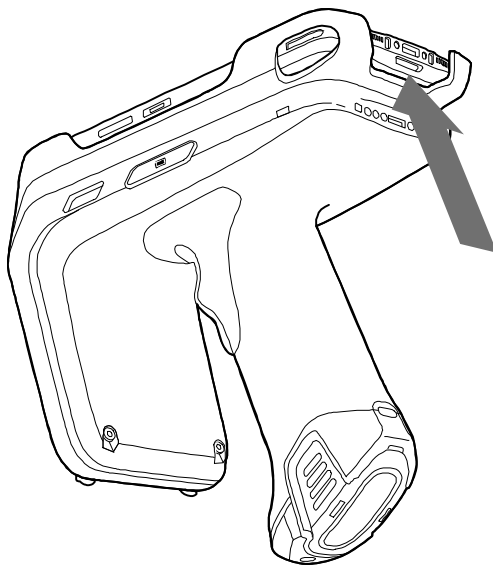

Sled Battery Replacement

Battery Installation

To install the battery:

1. Align the battery with the notch facing the back of the device.
2. Slide the battery into the handle of the device.
3. Snap the battery into place.

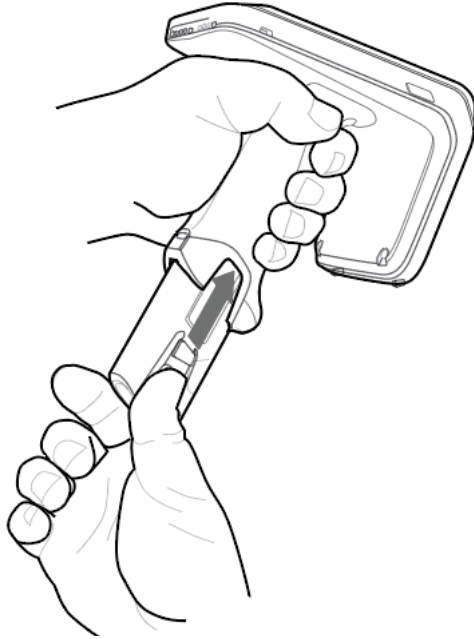

Battery Removal

To remove the battery, pinch the clips to unlock the battery and slide downwards to release.

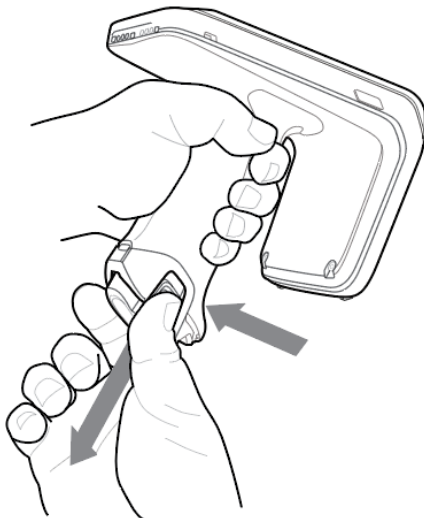

Charging

Before using the RFD40 for the first time, fully charge the battery by placing it in the charging cradle until the LED Power/Charging Indicator turns solid green. The RFD40 RFID sled and mobile computer may be charged in the charging cradle individually or attached together.

When an RFD40 RFID sled is removed from a charging cradle, it is automatically powered on. If a reader is not used for a duration of 30 minutes, the reader enters low power mode.

Figure 3 Single Slot Charging Cradle

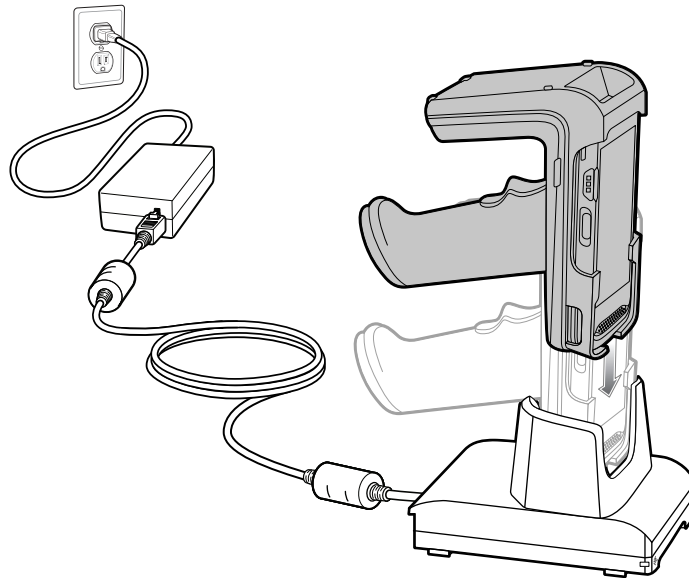

UI Indicators

The RFD40 RFID Standard sled presents multiple modalities to inform the user of various device states. The sled provides LED definitions for decode and battery status as well as beeper indications to indicate the charge progress of the battery. The trigger on the sled is capable of carrying out various programmable tasks to decode and initiate a bootloader recovery.

Decode LED Definitions

Table 2 RFD40 RFID Standard Sled Decode LED Indications

Scan	LED Status
Good Scan	Green
Scan Error	Red
RFID Tag Read Indicator Enabled	Green
Read Error	Red

Battery LED Definitions

Table 3 RFD40 RFID Standard Sled LED Definitions While Charging

Condition	Indication
Pre-charging	Amber (Fast, Fast, Slow)
Charging	Amber (Blinking)
Fully Charged	Green (Stays On)
Charging Error	Amber (Fast Blinking)
Firmware Update in Progress	Amber-Blinking

Battery Beeper Indications

Table 4 RFD40 RFID Standard Sled RFD40 Battery Beeper Indications

Condition	Tone
Low Battery (20%)	Medium-length tones
Lower Battery (10%)	Short tones - repeat
Suspend	High/Medium/Low
Charging	Short tone when the charger is connected.
Fully Charged	One Beep
Charging Error	Three Beeps (single occurrence)
Power On	Low/Medium/High Beep

Trigger Modes



NOTE: By default, the device assumes the upper trigger as the RFID decode trigger and the lower trigger as the mobile computer decode trigger.

Table 5 RFD40 RFID Standard Sled Default Trigger Functions

Condition	Upper Trigger	Lower Trigger	Both Triggers	Description
RFID Start/Stop	X	-	-	User Programmable.
Barcode Start/Stop	-	X	-	User Programmable.
Start Bootloader Recovery	-	X	-	Press and hold the lower trigger for five seconds while inserting the battery.
Configurable/Signal Intent to Mobile Device	-	-	X	Feature support is determined by the mobile computer being used with the device.

123RFID Mobile

This section describes the 123RFID Mobile Application which demonstrates the RFD40 RFID Standard sled's capability and tag operation functionality.

Requirements

Requirements for the 123RFID Mobile Application for Android are as follows:

- Zebra approved mobile computer compatible with the RFD40 Standard RFID sled.
- 123RFID Mobile Application APK.

Installing 123RFID Mobile

Install the 123RFID Mobile Application on the mobile computer from zebra.com/support or from the Google Play Store. The procedure to install the software on an Android device is dependent upon the Android version.

To install the software:

1. Connect the Android device to your computer. It is connected as MTP Device and shown as a drive on the computer. For information on transferring files using Media Transfer Protocol, refer to the Mobile Computer Integrator Guide at: zebra.com/support.
2. Navigate to Device Settings > Security and check Unknown Sources to allow installation of applications from unknown sources.
3. Copy the 123RFID_Mobile_1.0.x.x.apk file to the mobile device.
4. Go to Settings > Security and select Unknown sources.
5. Use the File Manager to locate the 123RFID_Mobile_1.0.x.x.apk file in the folder to which it is copied in [Step 3](#) and select it.
6. In the pop-up window, select the Android App installer to begin installation.

Using 123RFID Mobile

To use the application for RFID operations:

1. Launch the 123RFID Mobile Application for Android on the mobile device.
2. From the Readers list, tap on the available RFD40 device listed under Available Readers to connect and view the Rapid Read screen.
3. Tap **Settings > RFID > Advanced Reader Options > Antenna**. Power Level is set to 27.0 dBm by default. However, it is shown as 270 dbm because the value used is in units of tens of dBm. Japan units are set to a different default power level depending on the SKU type.

4. Tap the Back button and select Regulatory to set the region in which the device is operating.

Readers List

From the bottom navigation menu tap the **Readers icon**.

Figure 4 Settings - Readers List Screen

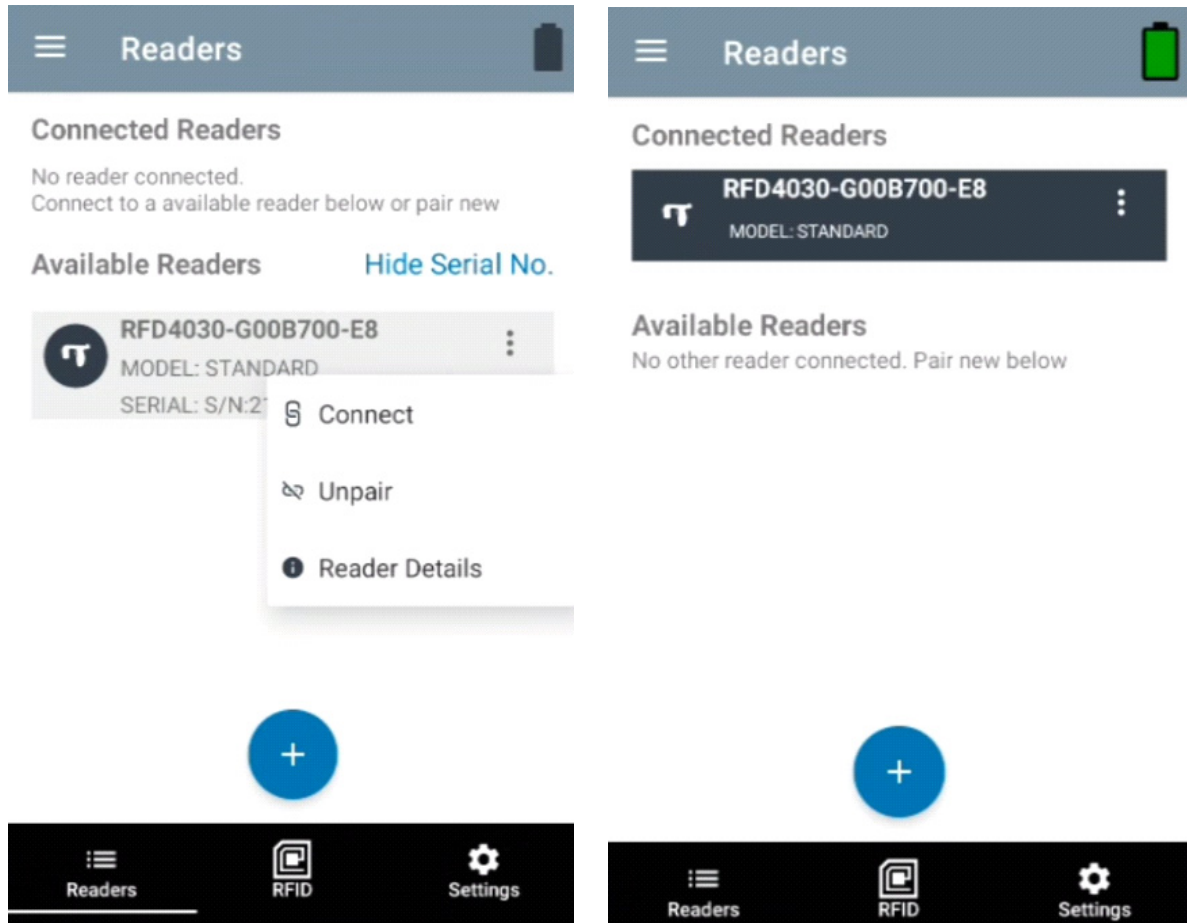

Tap a reader name from the **Readers List** to establish a session with the selected reader. Tap again to terminate the session. To obtain additional information about the device, tap **Reader Details**.

Figure 5 Reader Details

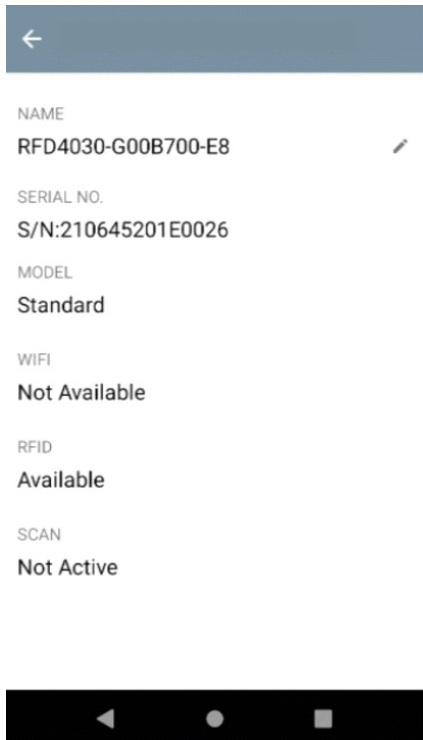

Updating the Device Firmware

Update the device firmware by tapping Firmware Update from the menu. Next, select the firmware version to be loaded onto the device and tap the Update Firmware button.

Figure 6 Firmware Update



Rapid Read

Tap **Rapid Read** from the **Home** or **Menu** screen.

Figure 7 Rapid Read Screen

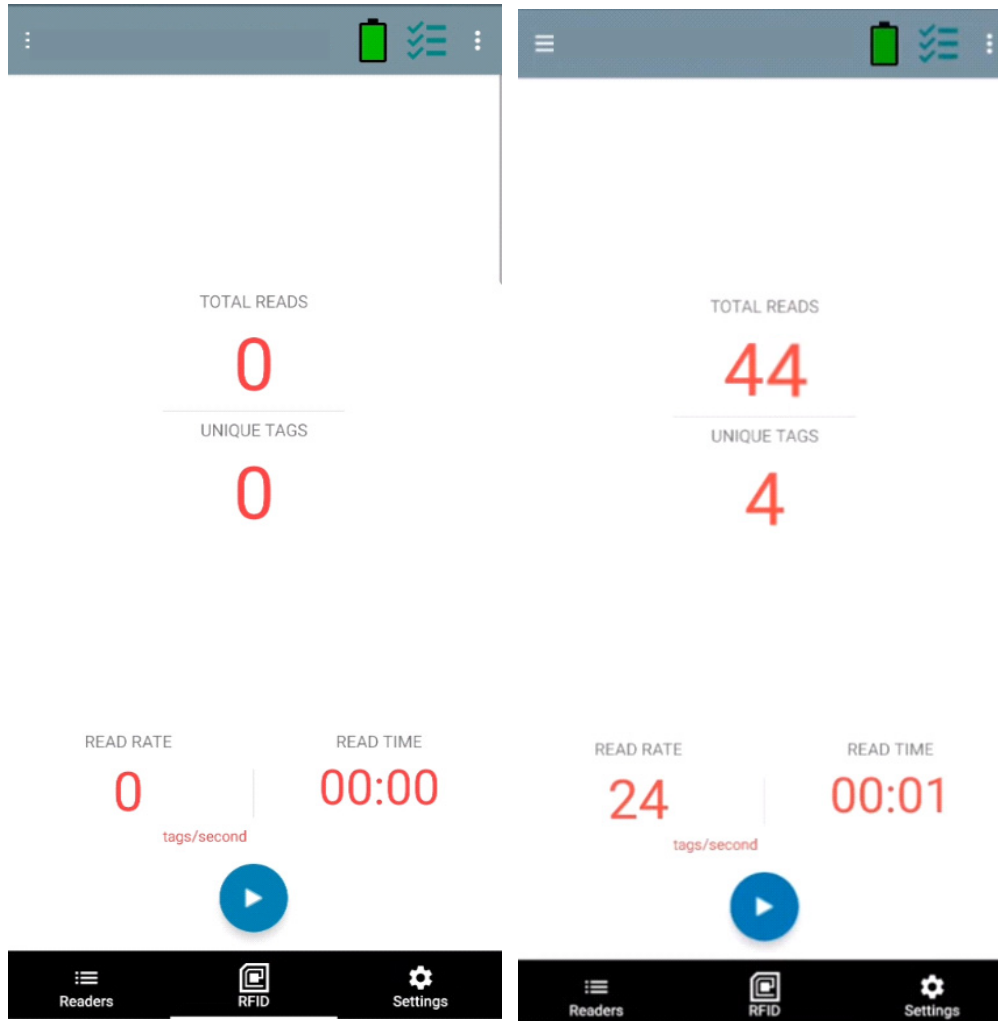

The Rapid Read and Inventory screens display the following data (see [Inventory on page 19](#)).

- Total Reads
- Unique tag count
- Read time (mm:ss)
- Tag read rate (tags/sec).

The Rapid Read and Inventory screens present two different views of the inventory operation on the reader. The **Start/Stop** functionality can be used interchangeably on both screens. For example, when operation starts on the **Rapid Read** screen and you navigate to the **Inventory** screen, the button available on the **Inventory** screen is **Stop**. The same is true when the operation starts on the **Inventory** screen. During the rapid read process, you can navigate to the **Inventory** screen to view tag details along with tag counts for each tag. The statistics displayed are maintained on the **Rapid Read** and **Inventory** screens regardless of the screen used to start the process.

Select **Start** to start the rapid read inventory operation. Select **Stop** to stop inventory operation.



NOTE The scan trigger on the device can also start and stop the inventory operation. Press the trigger to start, continue to hold and release to stop.

Progressing to another screen does not halt the operation. However, attempting to make changes or perform another operation while rapid read is in process results in an error.

Inventory

Once tags begin reading, the tag details populate the inventory screen. To filter the information by type, tap the Memory Bank dropdown menu and select User, Reserved, TID, or EPC.

Select **Inventory** from the **Home** or **Menu** screen.

Figure 8 Inventory Screen

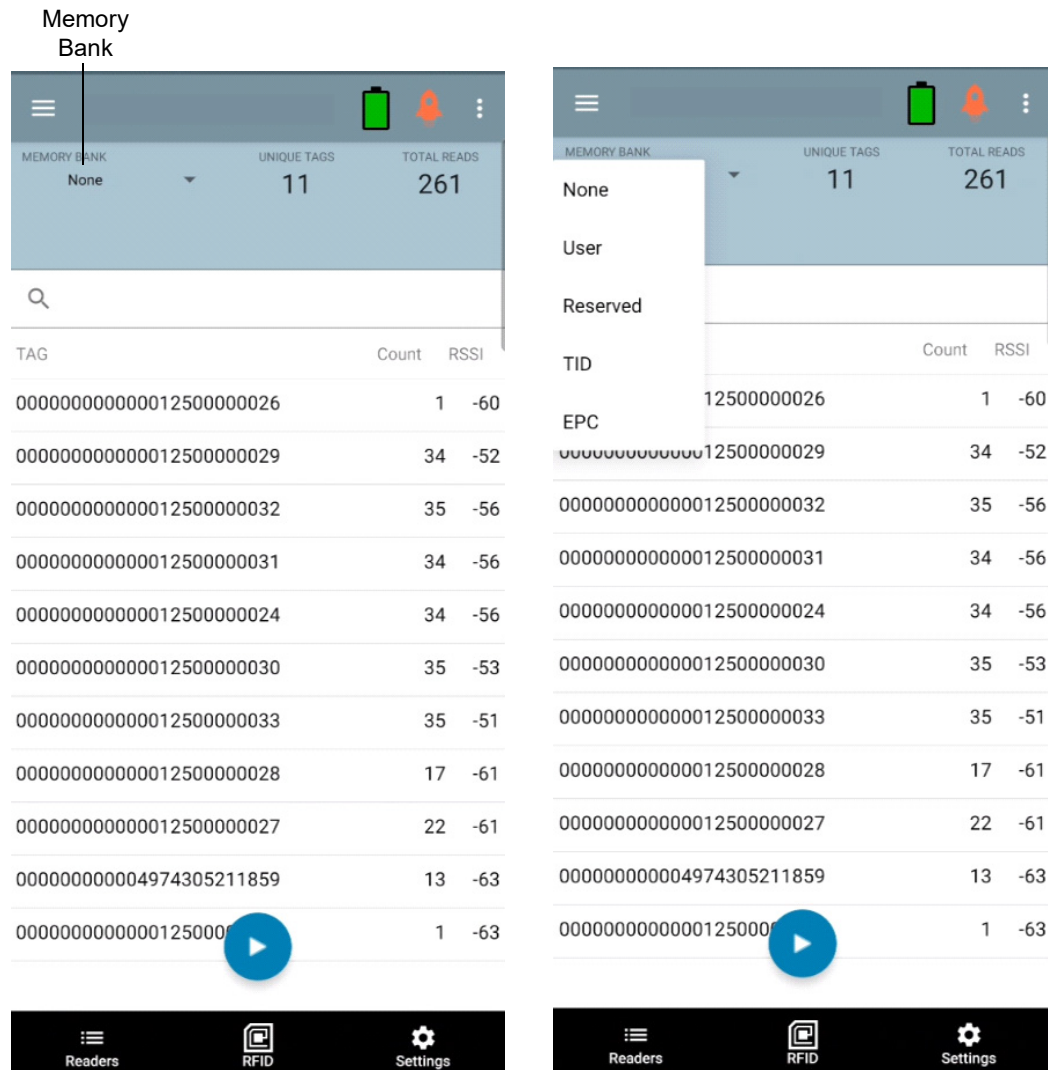

Tag reading is started and stopped on this screen as well as on the **Rapid Read** screen (see [Rapid Read on page 18](#)). When the process starts, tag information displays on the screen.

Tap **Start** to start the rapid read inventory operation. The **Start** button changes to **Stop**. Tap **Stop** to stop the read inventory operation.



NOTE The scan trigger on the device can also start and stop the inventory operation. Press the trigger to start, continue to hold and release to stop.

The tag ID selected can be filtered by **RFID Settings, Locate, Pre Filters, and Tag Write**. After selecting a tag, tap on the action bar **Locate** icon to go to the Locate screen. Tags are fully convertible to ASCII format. ASCII mode may be enabled by selecting **Settings > Application Settings**.

Figure 9 Tag Data Filters

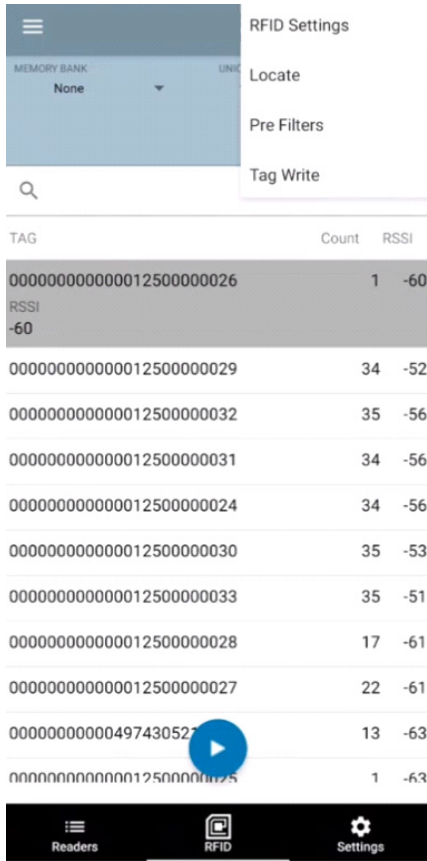

Locate Tag

Tap **Locate Tag** from the **Home** or **Menu** screen.

Figure 10 Locate Tag Screen

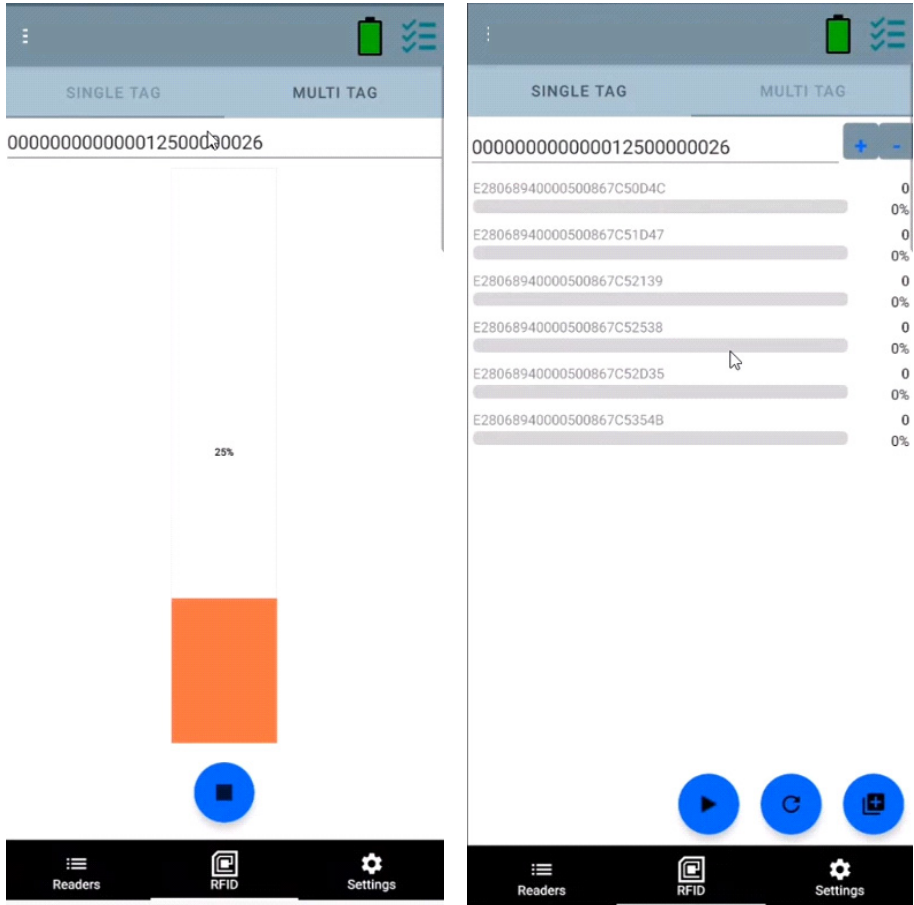

On this screen, enter the Tag ID in the text area or select a tag from the Inventory screen to pre-populate the Tag ID to search.

Tap **Start** to start the locate tag operation and tap **Stop** to stop. The device trigger can also be used to start and stop the operation.



NOTE The scan trigger on the device can also start and stop the inventory operation. Press the trigger to start, continue to hold and release to stop.

The color bar on the display shows the relative distance of the tag.

When the locate tag operation starts, moving to another screen does not stop the operation until **Stop** is selected.

Multi Tag

To locate and track multiple tags, select the Add a File icon on the multi-tag panel and select the file containing the specific tag information from the file manager to bring the file into the application.

Figure 11 Multi Tag File Upload

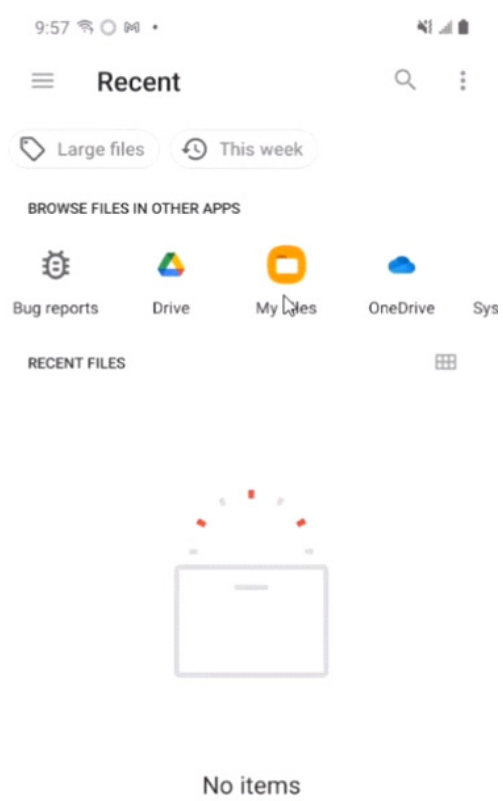

Inventory Screen Features

Table 6 Inventory Screen Features

Item	Description
Action Bar	
Tags	<p>Tap Memory Bank to select one of the following memory bank options from the drop-down menu:</p> <ul style="list-style-type: none"> • None - Defaults to EPC. • User - Allows reading user memory bank data when the tag is inventoried. • Reserved - Allows reading reserved memory bank data when the tag is inventoried. • TID - Allows reading TID memory bank data when the tag is inventoried. • EPC - Allows reading EPC memory bank data when the tag is inventoried. When the next inventory operation starts, the details from the selected memory bank displays. This menu is inactive if there is an ongoing operation on the connected reader. • Default Display - None.
Search	Tap the Search icon and enter a tag ID. Tags that match the entry display in the content area.
Power Management	Icon indicates if Dynamic Power is on. See Power Management on page 41 . Tap the Power Management icon to open the Battery Status screen.
Content Area (select a tag)	Tapping a Tag ID highlights the tag. The highlighted Tag ID is populated on the Tag Location text area as well as the Tag Pattern area in the Access Control screen. Tap Start to start searching for the tag. See Tag List Match Mode Operation on page 24 for more details. From this screen, return to the Menu or go to the Home screen and select Locate Tag .
Content Area (select a tag)	<p>The tags displayed in this area are based on the option selected from the memory bank. Tap the tag ID to expand details about the tag. Tap the tag ID again to collapse details.</p> <p>Example Default Tag Display: Tag IDTag Count AD99 15404190725965400404</p> <p>Example Expanded Tag Display: Note: Expanded tag detail can only display when the inventory operation is stopped. Memory bank data is shown only when inventory is complete.</p> <p>Tag IDTag Count AD99 15404190725965400404 EPC MEMORY3000 RSSI -50 Phase 1800 USER 1122334455667788AABBCCDDEEFF 1122334455667788AABBCCDDEEFF 1122334455667788AABBCCDDEEFF</p>

Tag List Match Mode Operation

When **Tag List Match Mode** is checked on the **Application** screen ([Application Settings on page 43](#)), the application identifies tags from a given set of tags in csv tag list format (comma separated values file). The contents of the csv file display on the **Inventory** screen. By default, the application displays friendly names from csv files.

Before the inventory starts, the count is zero. The tag list can be sorted using the drop-down menu choices. Select an option to display the type of tags to show when the inventory starts.

All: [Sample 4 Inventory List: Tag List Enabled; All Tag Option Selected on page 28](#)

Matching: See [Sample 1 Inventory List: Tag List Enabled; Matching Tag Option Selected on page 24](#).

Missing: See [Sample 2 Inventory List: Tag List Enabled; Missed Tag Option Selected on page 26](#).

Unknown: [Sample 3 Inventory List: Tag List Enabled; Unknown Tag Option Selected on page 27](#)

Sample Contents of Taglist.csv File

The csv file should contain only alphanumeric characters in the tag column. If there are any special characters, the row is discarded.

The Taglist.csv file must be located inside the rfid folder which must be manually created at the Android device root directory.



NOTE The folder name must be all lower case (for example, rfid and not RFID).

Figure 12 Taglist.csv File Contents

	A	B	C	D
1	30304035A880C80000123658	Item (*-*.001		
2	3035200EDC27074000123663	Item (*-*.002		
3	8DF0000000000000081291D	Item (*-*.003		
4	30304035A880C8000012364F	Item (*-*.004		
5	30304035A880C80000123644	Item (*-*.005		
6	30304035A880C8000012365C	Item (*-*.006		
7	30304035A880C80000123654	Item (*-*.007		
8	30304035A880C80000123710	Item (*-*.008		
9	30304035A880C80000123645	Item (*-*.009		

Sample 1 Inventory List: Tag List Enabled; Matching Tag Option Selected

When inventory starts, the application only displays the tag reads that match the tags in the taglist.csv file. Matching tags display in green. Select any tag read to show the matching tag details in the csv file.

Figure 13 Matching Taglist.csv File Contents

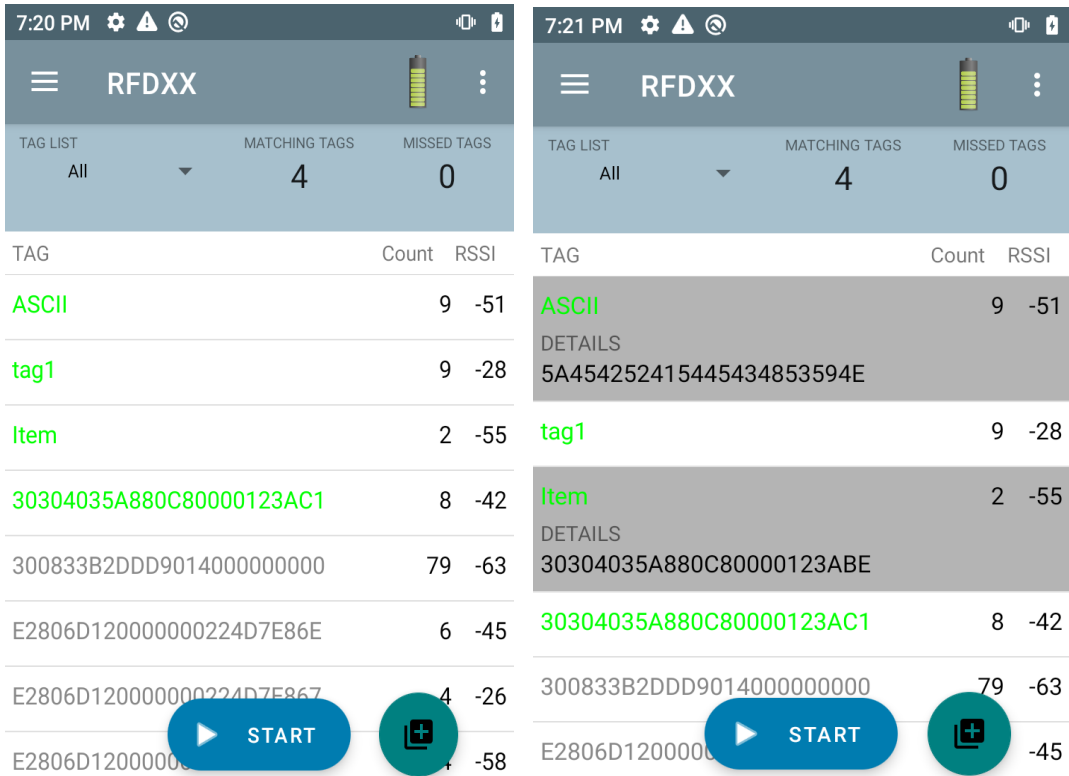

Sample 2 Inventory List: Tag List Enabled; Missed Tag Option Selected

When inventory starts, the application only displays the tag reads that are missed and included in the taglist.csv file. Missed tags display in red. Select any tag to show the missed tag details in the csv file.

Figure 14 Missed Taglist.csv File Contents

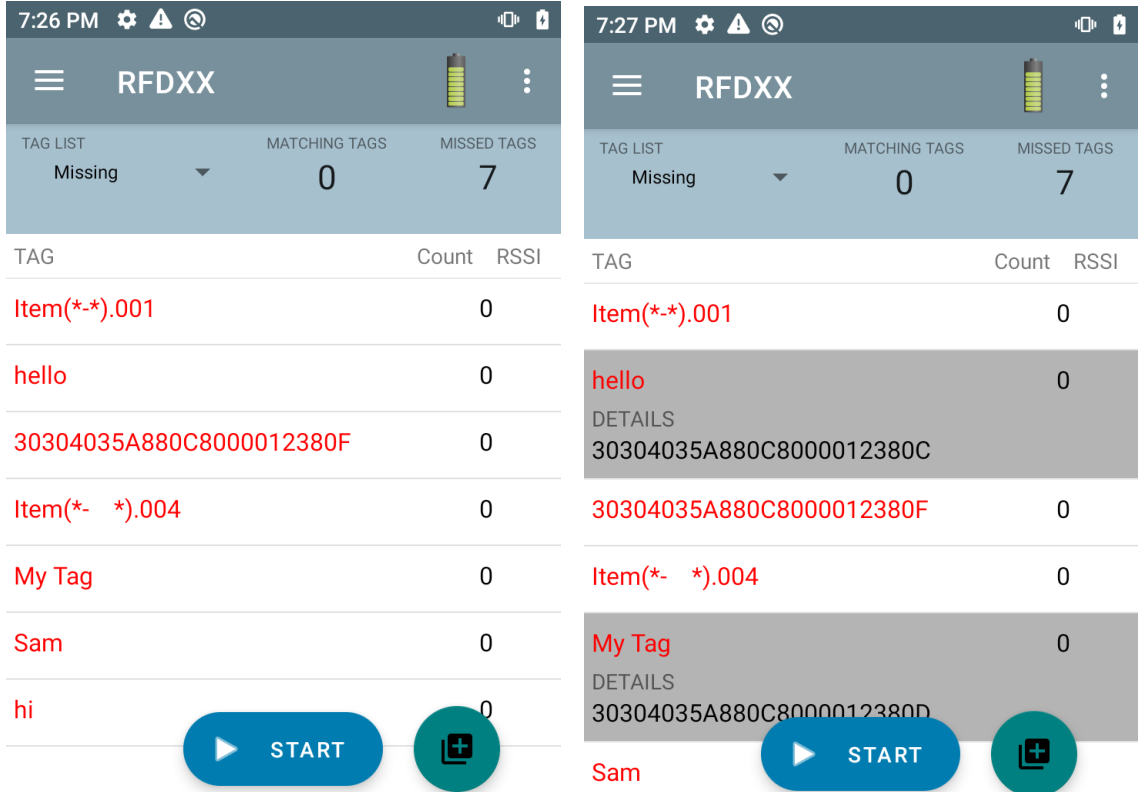

Sample 3 Inventory List: Tag List Enabled; Unknown Tag Option Selected

When inventory starts, the application only displays tags that were read but not included in the taglist.csv file. Unknown tags display in gray. Select any tag to show the unknown tag details.

Figure 15 Unknown Tags

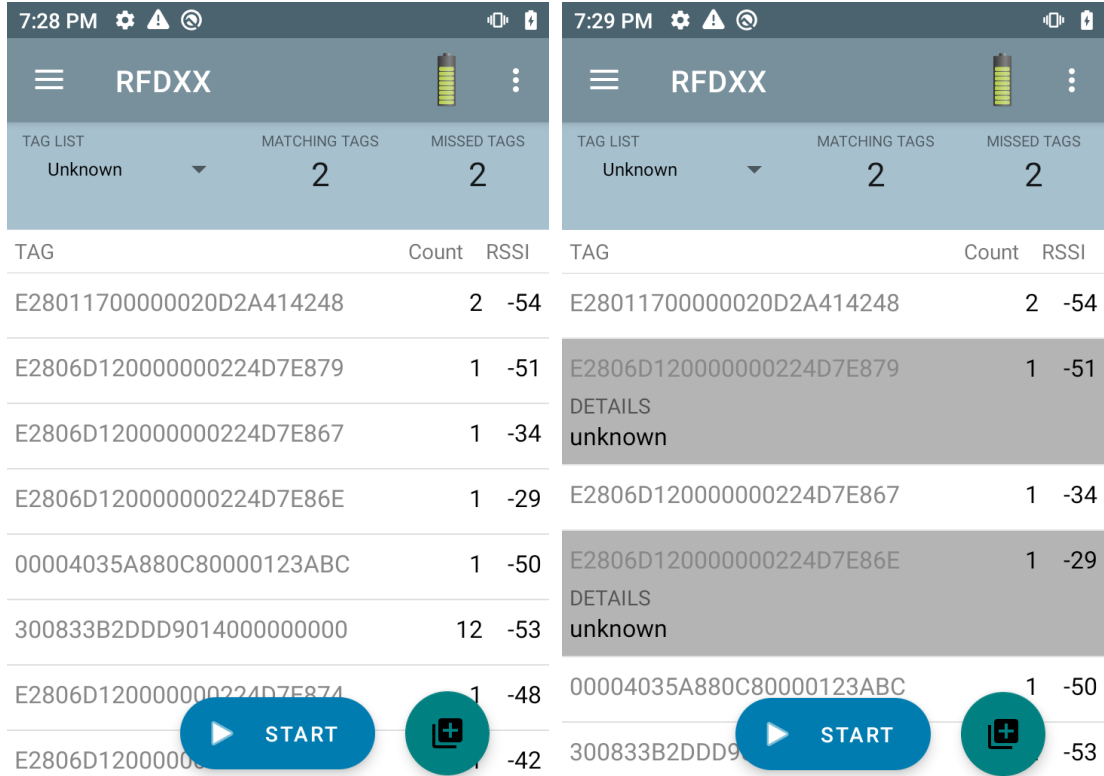

Sample 4 Inventory List: Tag List Enabled; All Tag Option Selected

When inventory starts, the application displays the tags for all of the options:

- Tag reads that match the tags in the taglist.csv file. Matching tags display in green. Select any tag read to show the matching tag details in the csv file.
- Tag reads that are missed and included in the taglist.csv file. Missed tags display in red. Select any tag to show the missed tag details in the csv file.
- Tags that were read but not included in the taglist.csv file. Unknown tags display in gray. Select any tag to show the unknown tag details.

Figure 16 All Tags

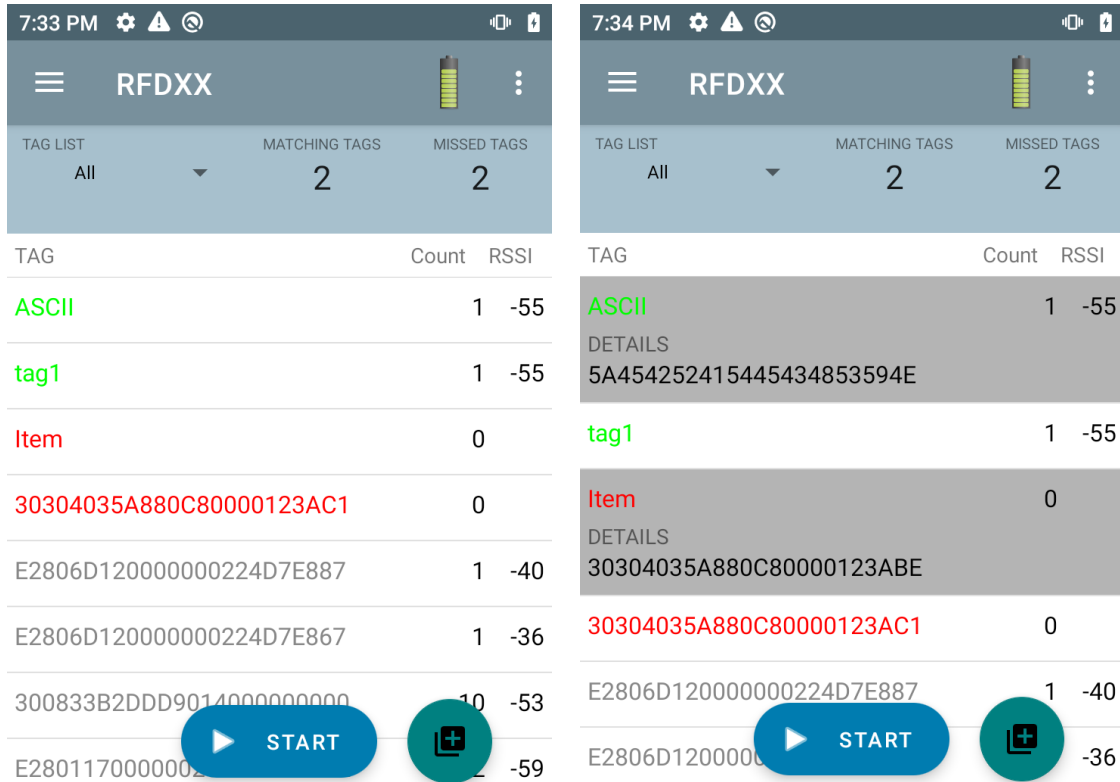

Sample 5 Tag List Matching Selected; Show Friendly Not Names Selected

When inventory starts, the application displays the tags for selected options from All, Matching, Missing, or Unknown. Application shows friendly names (i.e., Tag details instead of EPC) on screen.

Figure 17 Show Friendly Names Enabled

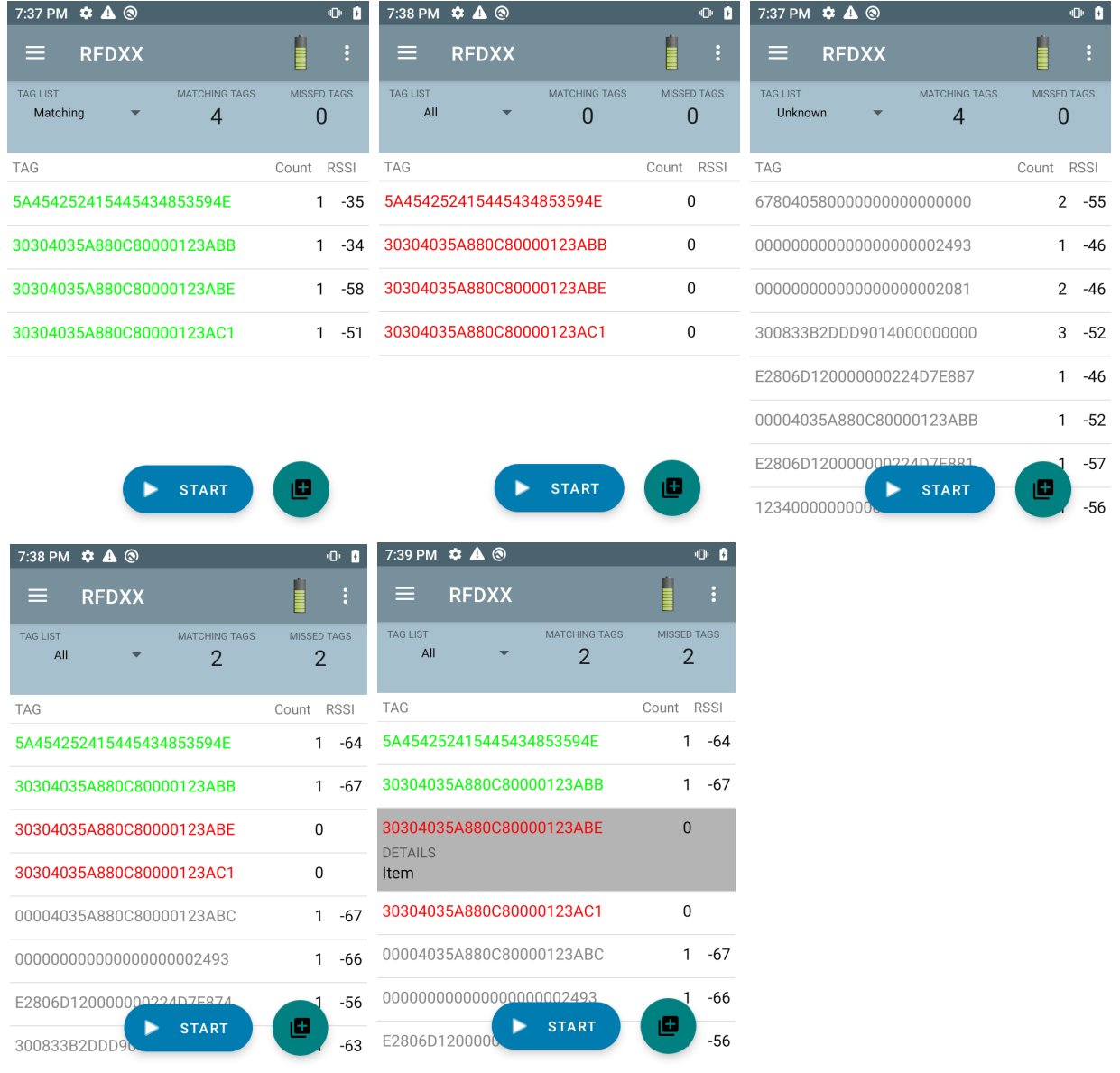

Sample 6 Exporting Data - Tag List Matching Selected

The [Application Settings](#) screen on [page 43](#) has the option to Export Data. If the option is checked, data is exported when the inventory stops. The tag content area is exportable to a file. For example, when **Matching** is selected from the menu to display only matching tags in the tag content area, the matching data can be exported to a file. The exported csv file includes the matching, missing, and unknown tag count shown in [Figure 18](#).

Figure 18 Exported File Content

INVENTORY SUMMARY			
	A	B	C
1	INVENTORY SUMMARY		
2	MATCH COUNT:	36	
3	MISS COUNT:	36	
4	UNKNOWN COUNT:	36	
5	READ TIME:	0:00:11	
6			
7	TAG ID	COUNT	
8	30304035A880C80000123658	0	null
9	3035200EDC27074000123663	13	MATCH
10	8DF000000000000000081291D	0	MISS
11	30304035A880C80000123644	18	MATCH
12	30304035A880C8000012365C	82	MATCH
13	30304035A880C80000123654	0	null
14	30304035A880C80000123710	7	MATCH
15	30304035A880C80000123645	1	MATCH
16	30304035A880C80000123656	0	null
17	303425485C27074000123662	476	MATCH
18	30304035A880C8000012364D	0	MISS
19	30304035A880C80000123650	0	MISS
20	8DF00000000000000007CCCC7	0	MISS
21	30304035A880C80000123705	0	MISS
22	30304035A880C80000123737	3	MATCH
23	30304035A880C8000012370F	28	MATCH
24	30304035A880C8000012371D	27	MATCH
25	30304035A880C80000123721	8	MATCH
26	30304035A880C80000123736	0	null
27	AD99160042DB2190540000C6	0	MISS
28	8DF0000000000000000812998	0	MISS
29	30304035A880C8000012364C	0	MISS
30	30304035A880C80000123652	0	null
31	30304035A880C80000123664	532	MATCH
32	30304035A880C8000012364E	0	MISS
33	30304035A880C8000012364A	0	MISS
34	30304035A880C80000123657	0	null

Unique Tag Reporting

When **Unique Tag Reporting** is enabled on the [Tag Reporting](#) screen on [page 39](#), the reader reports only unique tags based on the options below.

- When the **Matching** option is selected (see [Sample 1 Inventory List: Tag List Enabled; Matching Tag Option Selected on page 24](#)) the tag count cannot be greater than one because the unique tags are only reported one time.
- When the **Matching** option is not selected, the list displays unique and total reads. The tag count cannot be greater than one because the unique tags are only reported one time.

Settings

To access the Settings of the device, tap the Settings Icon from the bottom navigation bar. Settings is split up into General Settings to configure settings on the device, RFID Settings to configure specific reader and antenna settings, and Application settings to make changes to the 123RFID Mobile application settings.

General Settings

Figure 19 Settings Screen

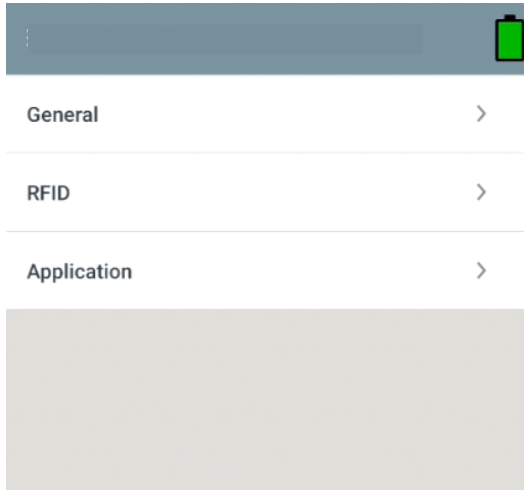

Table 7 General Settings Screen Options

Settings Option	Description
Firmware Update	Update the firmware on the reader.
Factory Reset	Reset the settings on the reader to Factory Defaults.
Enable Logging	Enable the logging of tag reads.
Device Info	View information such as friendly name, serial number, model, and RFID/scan settings.
Share File	Share a file with a paired device.
Trigger Mapping	Designate the Upper Trigger for RFID decode and the Lower Trigger for Host Scan or the Upper Trigger for Host Scan and the Lower Trigger for RFID decode.

Updating the Device Firmware

Update the device firmware by tapping **Firmware Update** from the menu. Next, select the firmware version to be loaded onto the device and tap the Update Firmware button.

Figure 20 Firmware Update



RFID Settings

Figure 21 Settings Screen

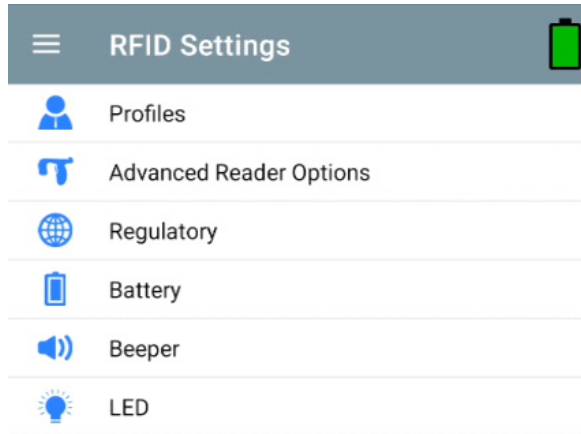

Table 8

RFID Settings Option	Description
Profiles	Displays Fastest Read, Cycle Count, Dense Readers, Optimal Battery, Balanced Performance, User Defined and Reader Defined profiles.
Advanced Reader Settings	Antenna, Singulation, Control, Start/Stop Triggers, Tag Reporting, Power Management and Save Configuration
Regulatory	Allows region and channel selections.
Battery	Displays the device battery status.
Beeper	Use to turn the beeper on/off, and set volume.
LED	Enables/Disables the device tag read LED indicator.

Profiles

To display the list of profiles, tap **Settings > Profile**.

- The currently selected profile is highlighted in orange.
- Tap profile item to expand the profile and view applicable configurations.
- Profiles can be selected or disabled by using the slider switch to the right of the profile name.



NOTE If Power Level, Link Profile, Session, or Dynamic Power are modified from each respective screen, then the currently selected profile changes to User Defined profile and profile item values are modified with same values.

Profile setting options are as follows:

- Fastest Read - Read as many tags as fast as possible.
- Cycle Count - Read as many unique tags as possible.
- Dense Readers - Use when there are multiple readers within close proximity.
- Optimal Battery - Provides best battery life.
- Balanced Performance - Maintains balance between performance and battery life.

- User Defined - Custom profile used for custom requirements.
- Reader Defined - Maintains reader configurations.

Figure 22 Profiles Settings

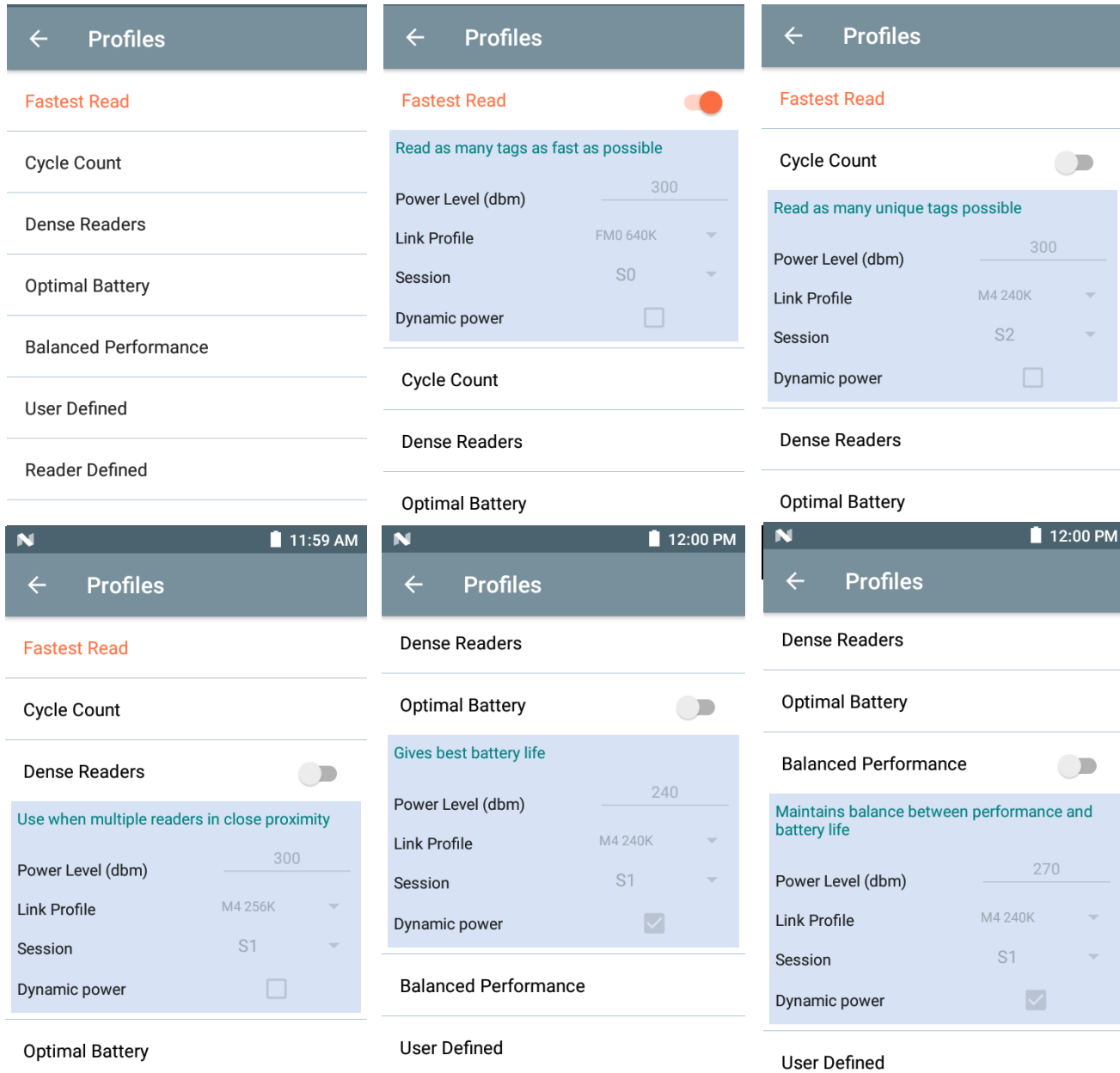

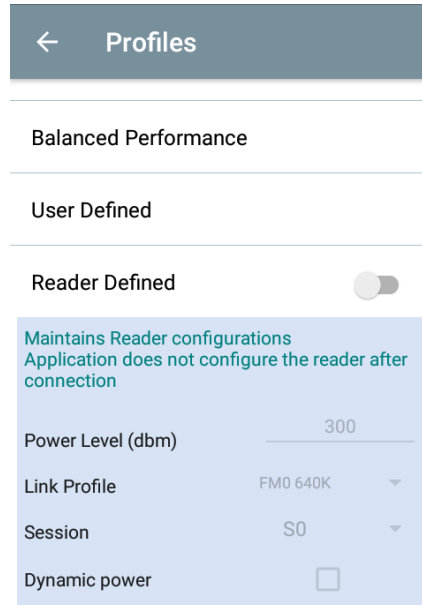
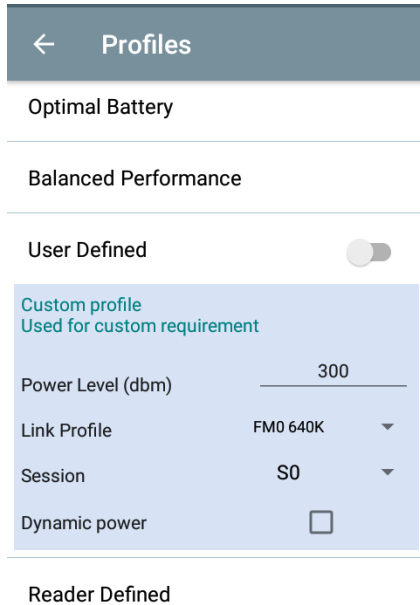

Advanced Reader Settings

Antenna

To access the Antenna screen, go to: **Settings > Advanced Reader Options > Antenna**. The Antenna screen displays the following:

- **Power Level** - Displays the current selection and a text box for available power levels (as reported by the device). The default setting is 27.0 dBm (shown as 270; the value displayed is in units of tens of dBm). Japan units are set to a different default power level depending on the SKU type.

The minimum power level when DPO is enabled is 3.1 dBm. When DPO is disabled, the minimum power level is 0 dBm.

- **Link Profile** - Displays the current selection and includes a drop-down list of available link profiles (reported by the device).

Link Profile display format is as follows: Return link bit data rate in bis per second (e.g., 60000 -> 60 Kbs); Miller Value (e.g., MV_4 -> Miller 4); thus profile name M4 240K (240K becomes BLF) modulation type (PR ASK is the only one supported).

- **PIE** value has no units and is either 1500 and 2000 minimum.
- **Tari** applicable Tari value in thousands of micro seconds (e.g., 6250 -> 6.25 microseconds).

Figure 23 Antenna Screen

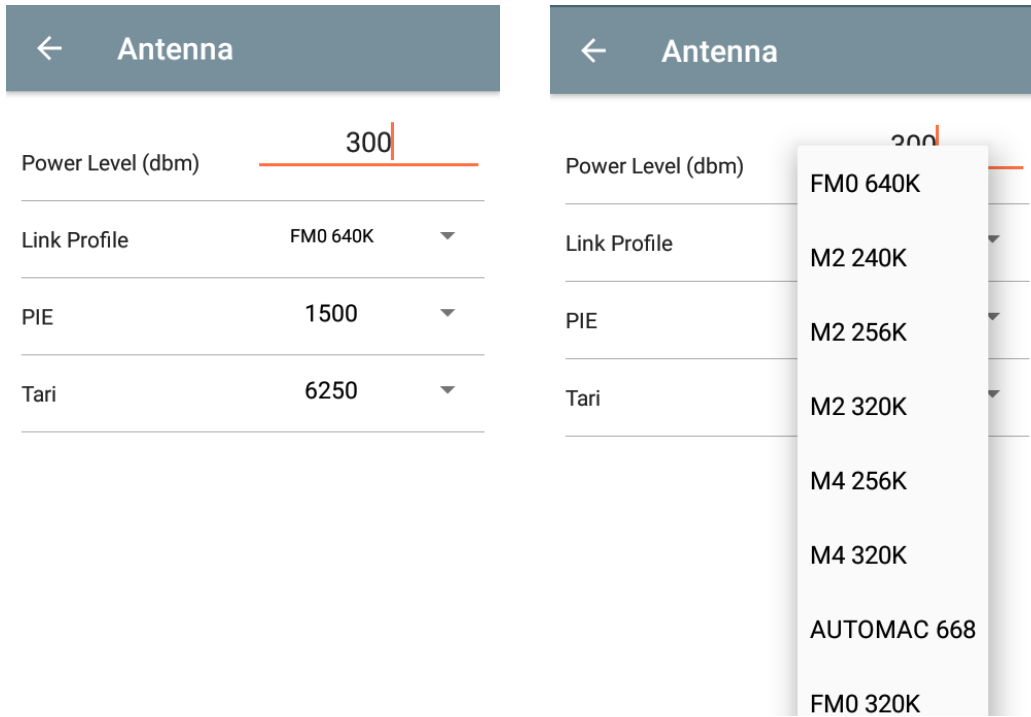

NOTE The Power Level and Link Profile are blank when there is no connection to the reader.

Singulation Control

To access Singulation Control, go to: **Settings > Advanced Reader Options > Singulation Control**. View or configure the singulation control settings for each antenna.

- **Session** - The drop-down list includes the available session options (S0, S1, S2, S3).
- **Tag Population** - A numeric value of the estimated number of tags in the Field of View (FOV). Values shown are 30, 100, 200, 300, 400, 500, 600.
- **Inventory State** - State A, State B, AB Flip.
- **SL flag** - ALL, DEASSERTED, ASSERTED.

Figure 24 Singulation Control Screen

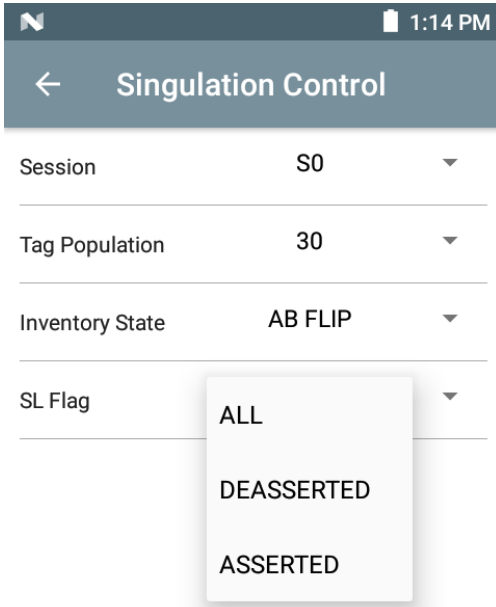

Start and Stop Triggers

To access the Start and Stop Triggers screen, go to: **Settings > Advanced Reader Options > Start\Stop Triggers**.

The **Start Trigger** Periodic displays the Period input box (in milliseconds).

The **Stop Trigger Duration**, **Tag Observation** and **N attempts** display numeric value input boxes. All time entries are in milliseconds.

All the required details for saving triggers to the reader must be entered or the application does not save the trigger settings to the reader.

Figure 25 Start and Stop Triggers Screen

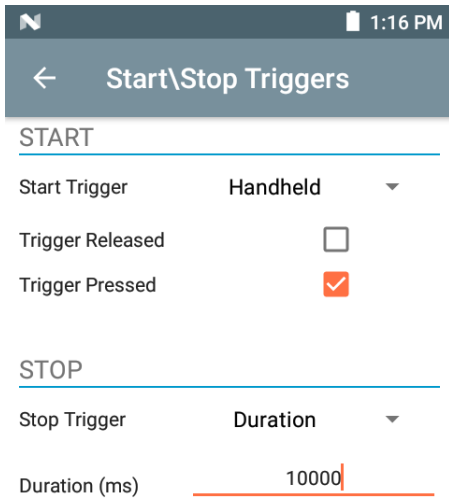

Required input for Start/Stop Trigger settings are as follows:

- Start Trigger
 - **Immediate** (default)
 - **Hand-held** - Select either the **Trigger Pressed** or **Trigger Released** check box.
 - **Periodic** - Enter the period of time in milliseconds.
- Stop Trigger
 - **Immediate** (default)
 - **Hand-held** - Select either the **Trigger Pressed** or **Trigger Released** check box along with **Timeout** in milliseconds.
 - **Duration** - Enter duration in milliseconds.
 - **Tag Observation** - Enter the tag count along with timeout in milliseconds.
 - **N Attempts** - Enter the number of attempts along with timeout in milliseconds.

If the start trigger type is set to Hand-held trigger (pressed or released), the application sets the repeat for the operation to ensure the use case if repeated operations can be demonstrated.

If any trigger is defined as Hand-held, the application does not act on immediate trigger type for a Hand-held trigger action.

Tag Reporting

To access Tag Reporting, go to: **Settings > Advanced Reader Options > Tag Reporting.**

Figure 26 Tag Reporting Screen

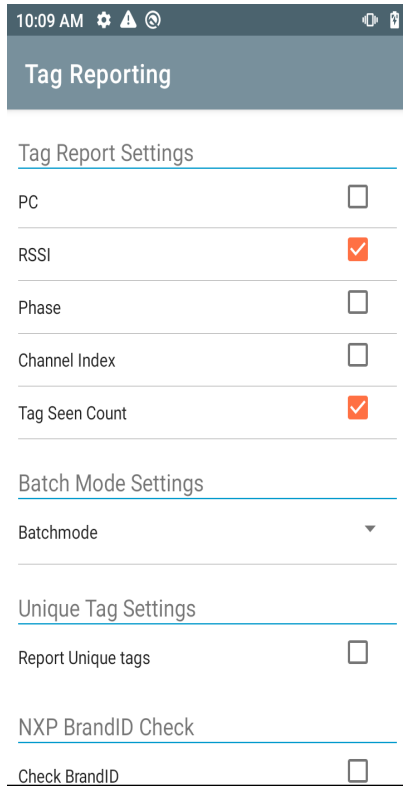

Table 9 Tag Reporting Screen Options

Option	Description
PC	Select to allow reporting the PC as part of the Tag Data.
RSSI	Selection indicates whether or not the RSSI (Received Signal Strength Indication) is reported as part of the Tag Data.
Phase	Select to indicate whether or not the Phase is reported as part of the Tag Data.
Channel Index	Select to indicate whether or not the Regulatory Channel Index is reported as part of the Tag Data.
Tag Seen Count	Select to indicate whether or not the Tag Seen Count is reported as part of the Tag Data.
Report Unique Tags	When this option is enabled, the reader reports only unique tag reads. The Unique Tag reporting feature can be enabled when using Tag List Match mode.

Power Management

This screen provides an option to enable **Dynamic Power Optimization (DPO)** in the reader. Enabling DPO enhances battery life during inventory operations.



NOTE DPO is enabled by default. It is not necessary to disable DPO when executing access operations or using filters because DPO is automatically disabled and when the operation is complete, it is automatically enabled.

If **Dynamic Power** is On, a green battery icon appears in the title bar of the application. Tapping on this opens the **Battery Status** screen.

To access Power Management, go to: **Settings > Advanced Reader Options > Power Management**.

Figure 27 Power Management Screen

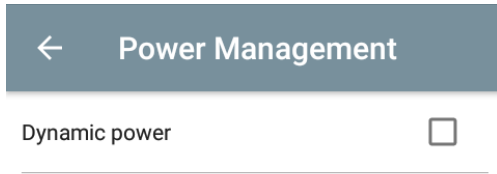

Dynamic Power optimization config-
ures the reader for best battery life
and works with Pre configured set-
tings. Dynamic Power optimization
works only for inventory operation

Save Configuration

To access Save Configuration, go to: **Settings > Advanced Reader Options > Save Configuration**. This screen is used to save the settings and displays the current settings on the device.

The settings are saved on the device until a reset to factory defaults is performed on the unit (see [Settings on page 31](#)).

The Tag Pattern area is automatically filled in when a tag is selected in the Inventory screen.

Figure 28 Save Configuration Screen

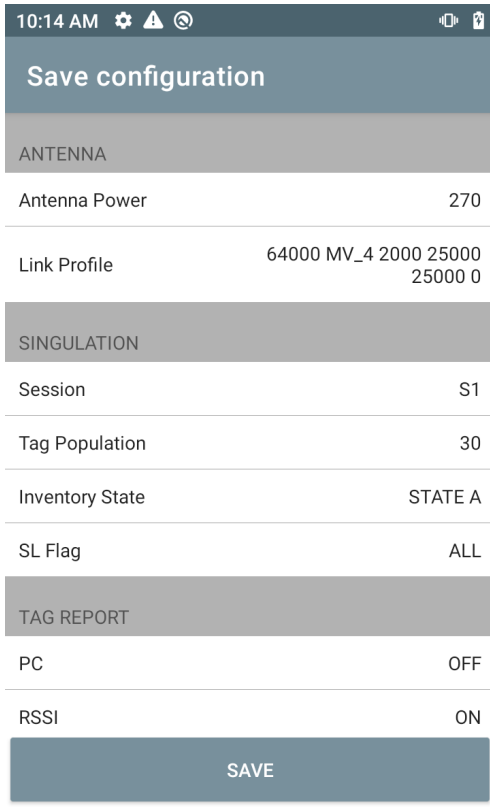

Access Control

Figure 29 Access Control Screens - Read/Write, Lock, Kill

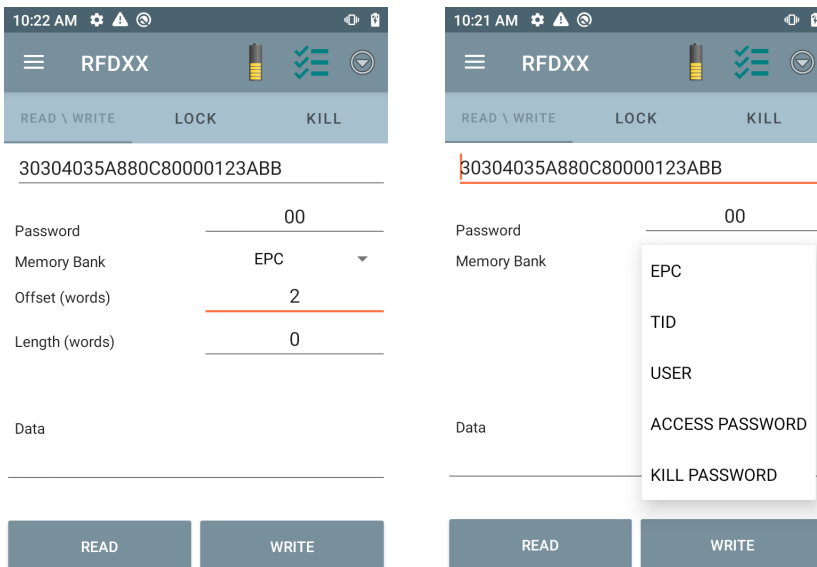

The Tag Pattern area is automatically filled in when a tag is selected in the Inventory screen.

Read/Write

The Read/Write access operation is simplified with offset and length fields are hidden. The user can tap the more/advanced options icon to see offset and length fields. Tap the icon again to hide the advanced options.

Memory Bank options now have extended menu options to choose directly interested area of memory bank. This avoids typing of offset and length etc.

Read/Write

Read/Write options are:

- **Tag ID and Password** values are in hex. Tag ID is edited.
- **Memory Bank options** - EPC, TID, USER, PC and CRC, Access Password, Kill Password.
- **Offset and Length** values are in 16-bit words. This is only available after tapping the **Advance Options** icon. To toggle visibility, tap **Advanced Options** again.
- **Access operation** screen maintains edited tag ID.

Lock

Lock privilege options are as follows:

- Read and Write
- Permanent Lock
- Permanent Unlock
- **Unlock**

Kill

Permanently renders the tag unusable. A **Kill Password** must be provided.

Application Settings

From the **Settings** screen, select **Application**.

Figure 30 Settings - Application Screen

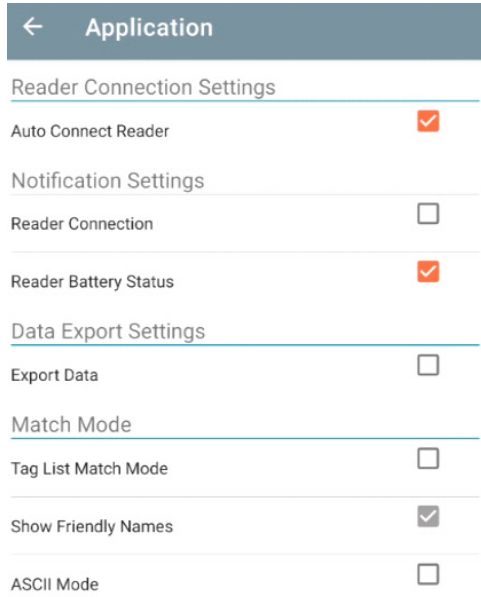

Table 10 Application Settings

Settings Option	Description
Auto Reconnect Reader	When checked, the device connects to the RFID service which manages the connection to the reader.
Reader Connection Notification	When checked, the application notifies the user when the reader is connected or disconnected.
Reader Battery Status Notification	When checked, the application notifies the user when the battery has reached specific critical states.
Export Data	When checked, the application writes the inventoried RFID data to a file when the inventory operation stops. On Android platforms the file is saved in a fixed directory. Check the files in file browsing in the Inventory directory (Sdcard/inventory/<files>). The files may be copied to a PC.
Tag List Match Mode	Check to enable matching mode.
Show Friendly Names	Check to show the tag's friendly names instead of EPC ID. Show friendly names is only available when Tag List Match Mode is enabled.
ASCII Mode	Displays tag ID in ASCII format. If the full tag ID or memory bank data is convertible to ASCII format, then the application only shows the same. Inventory, Locate, Access, and Pre Filters show ASCII mode represented data in respective sections.

123RFID Desktop Application

123RFID Desktop is a setup and optimization tool for the RFD40 Standard RFID Sled. This section describes the application and its features.

123RFID Desktop Features

- Connect - allows users to search for readers on the local subnet or USB port.
- Read - allows users to start an inventory, view summary metrics on tag reads and sort, filter and export tag data. Select an antenna and set the power level to begin building an inventory.
- Configure - allows users to configure reader and antenna settings. Settings can be saved to a file or as a printed report.
- Firmware - allows users to update the firmware on up to five devices.

Connect

Users can locate readers on the local subnet or via USB port by clicking the **Find Readers** button or by entering the IP, hostname or COM port and clicking **Connect**.

Figure 31 Adapter Installation

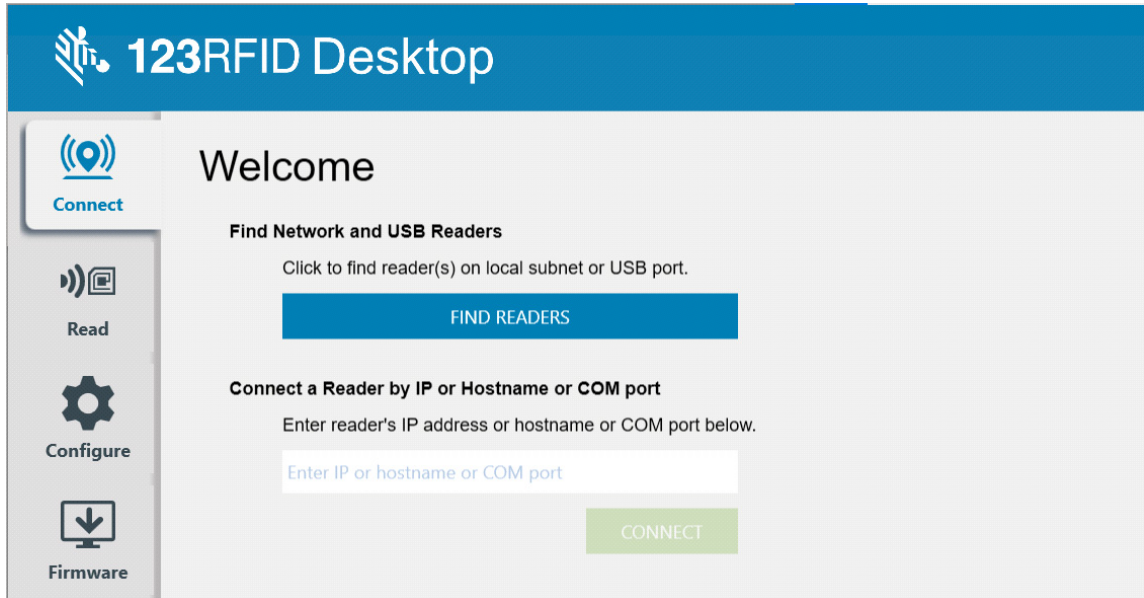

To discover readers on the network view the Available Readers section of the application and click Connect on one of the associated rows to connect to the specified reader.

Figure 32 Reader Discovery

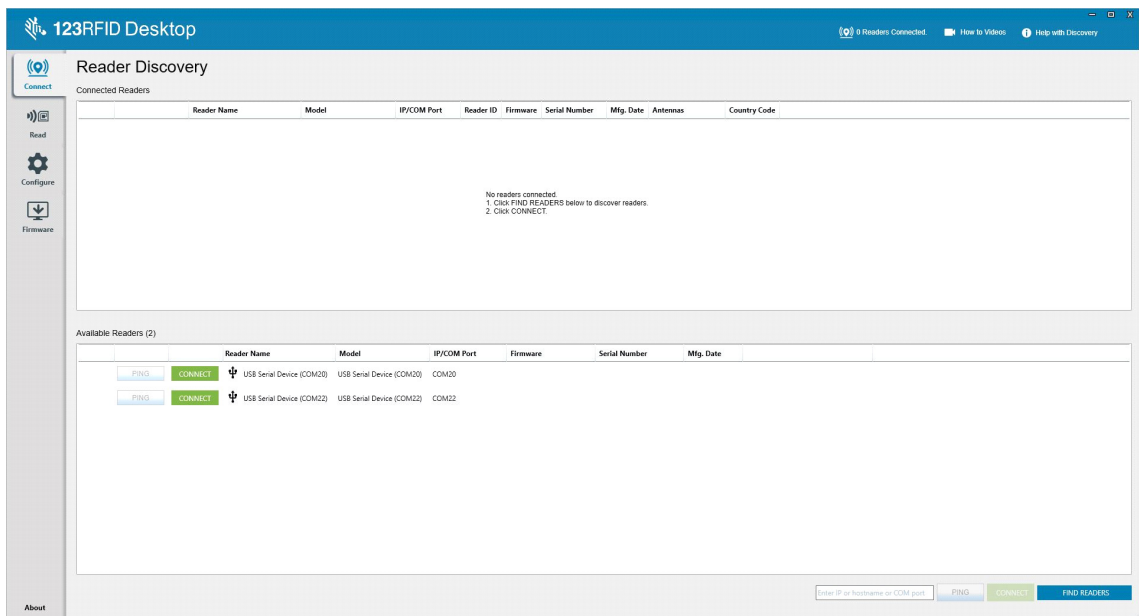

Read

The read feature allows users to start an inventory. Users can view summary metrics on tag reads by reader, sort, filter and export tag data to a file. Select antenna and set power level to do inventory.

Figure 33 Data View

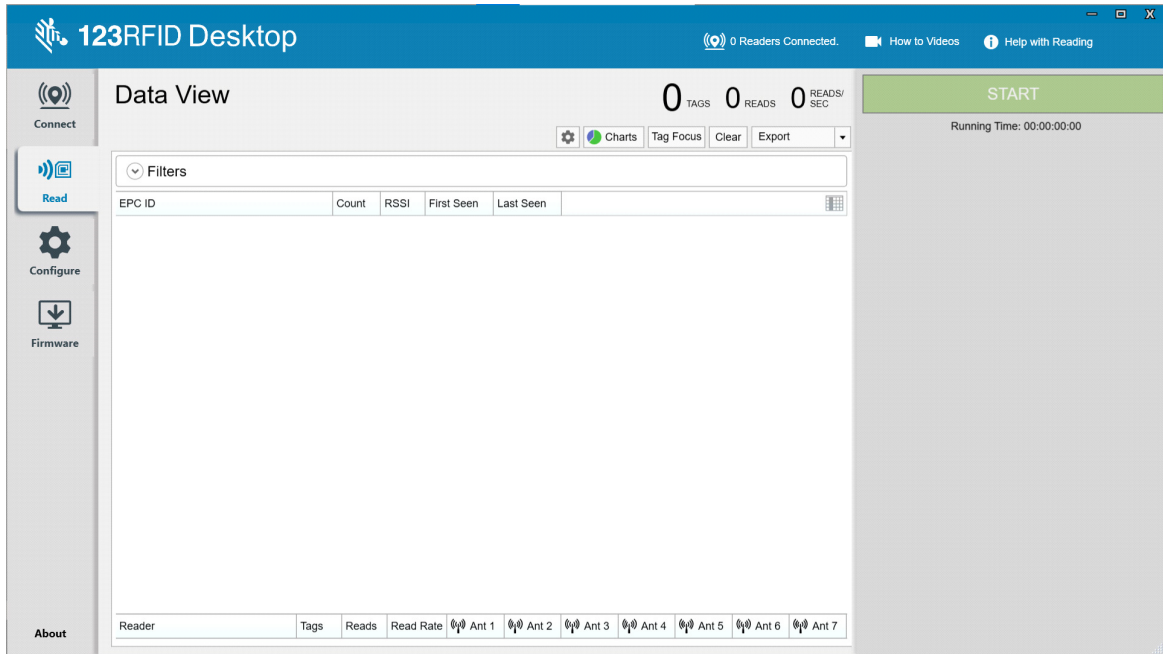

Click the **Start** button to start reading tags and recording an inventory.

Figure 34 Inventory View

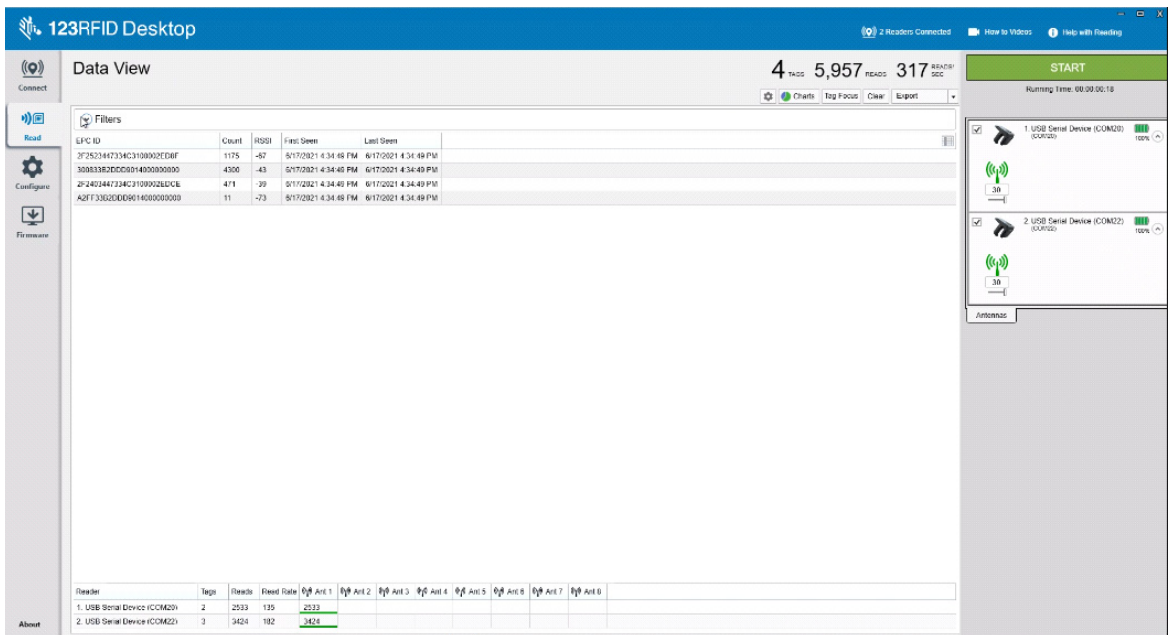

To download the inventory data for offline view:

1. Click the Export button to export tag data to excel.

- a. Export Summary – Save a snapshot of all the tag reads displayed on Read screen, in excel.
- b. Export History – Save timeline data for tags read, in excel.

To edit access operation information on a specific tag, select and double click on the associated tag row.

Figure 35 Access Operations

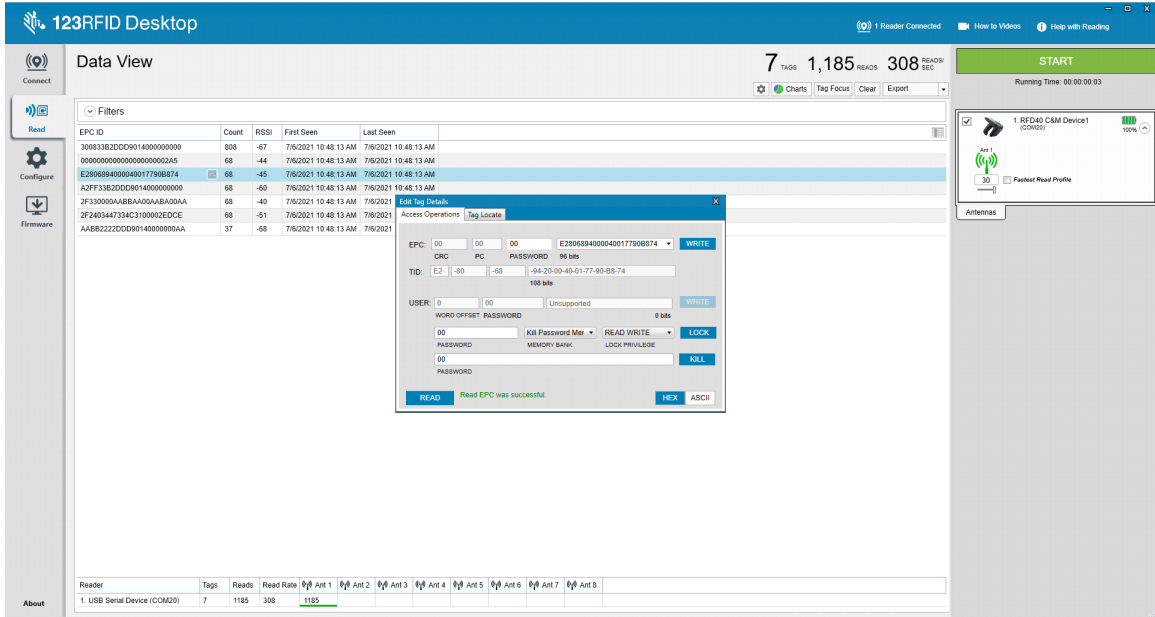

To access specific tag location details, click on the **Tag Locate** tab.

Figure 36 Tag Locate

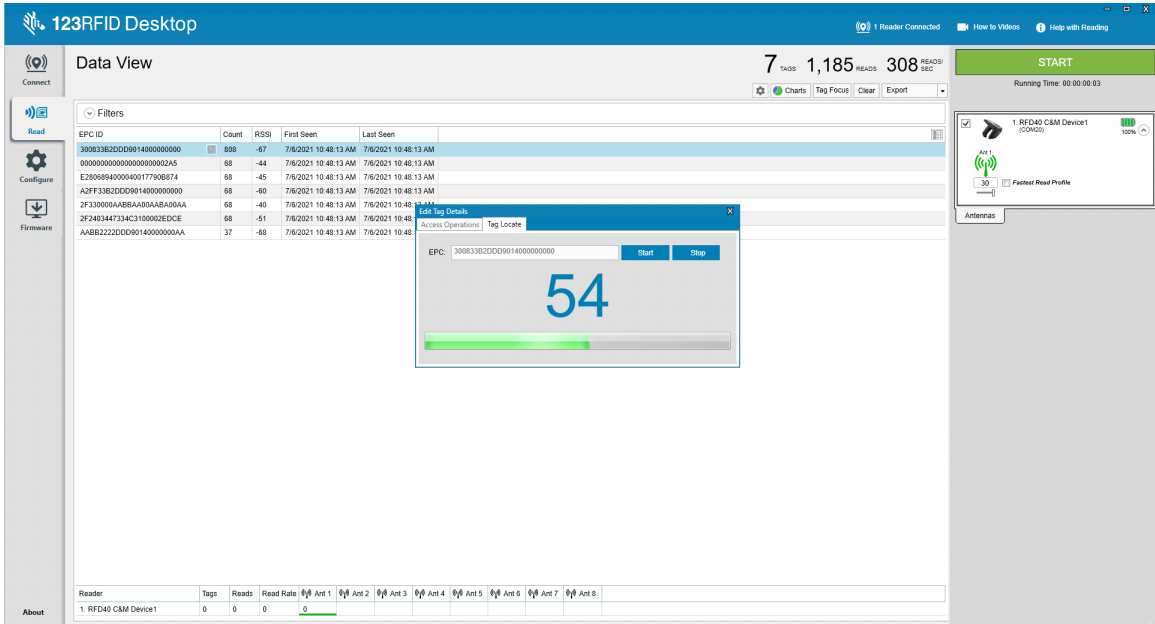

Reader Configuration

The Reader Configuration wizard configures the reader and antenna settings and saves them instantly. Users can also save settings to a file on the PC or print a report.

1. Click **Edit Configuration on Reader** to edit reader's settings and use the wizard to do the following:
 - Assign names to reader and its connected antennas.
 - Set antenna settings or reset them to factory defaults.
 - Change reader's region configuration.
 - Create rules for your GPIO (General Purpose Input/Output) accessories on when to trigger inventory and output results.
 - Save/print configurations to a file.
2. Click **Load a Saved Configuration File to Reader** to load a saved configuration file from the PC to another connected reader.

Figure 37 Configuration Settings

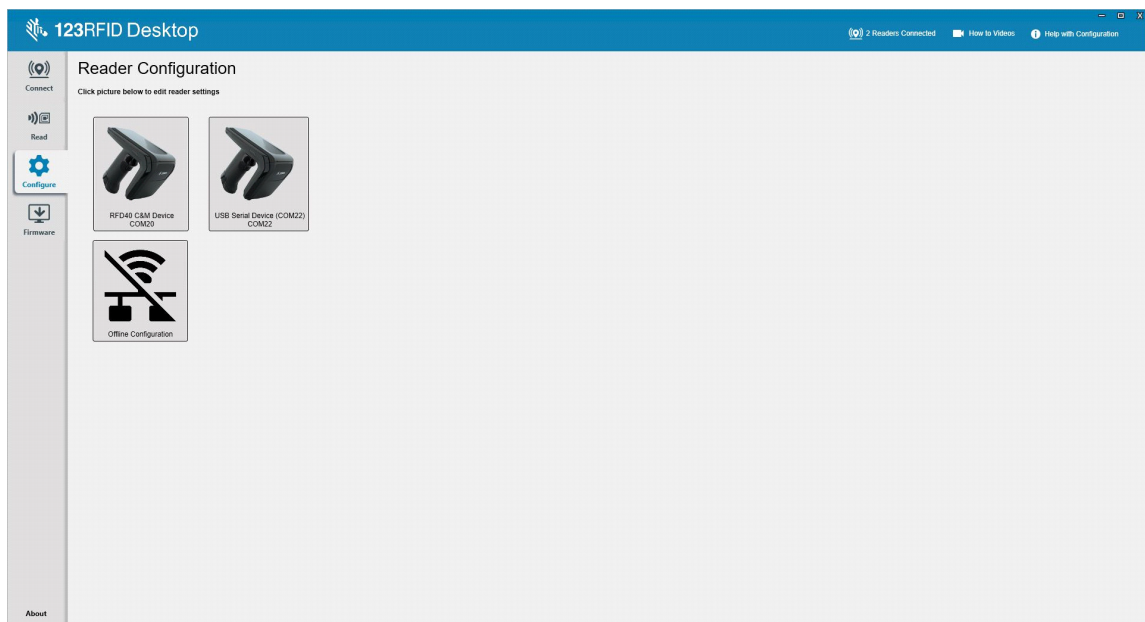

Reader Name

Add a description or name the reader by filling out the form fields on the name screen.

Figure 38 Name Screen

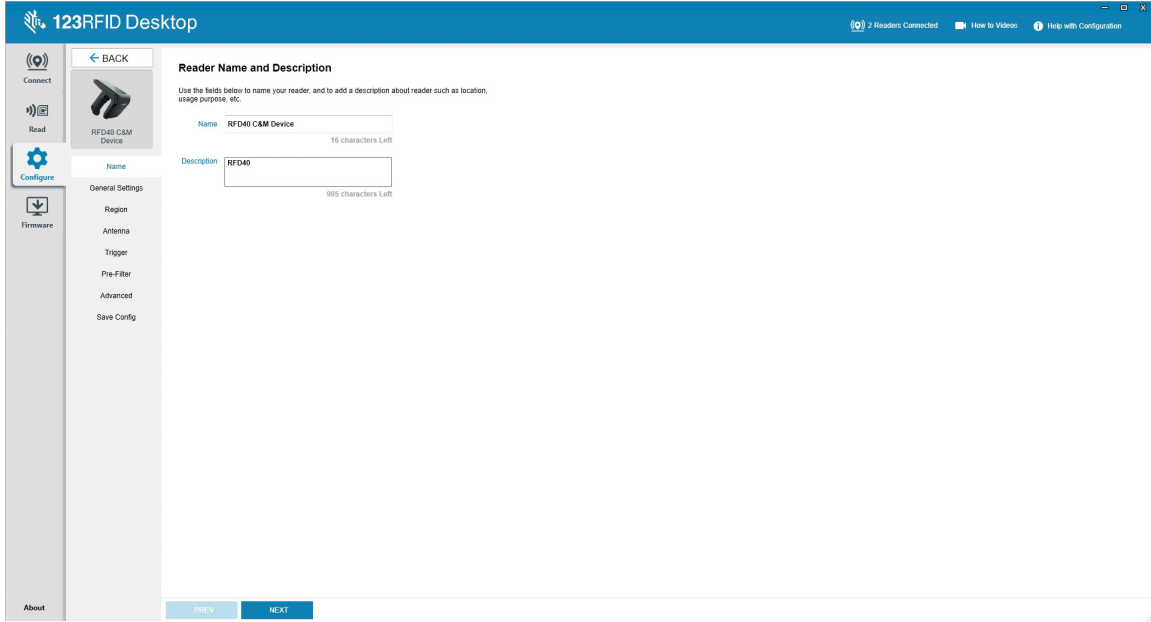

General Parameter Settings

Configurable general parameter settings include trigger mode (RFID or barcode), beeper volume (high/medium/low/quiet), dynamic power (enable or disable) and unique tag reporting (enable or disable).

Figure 39 General Settings

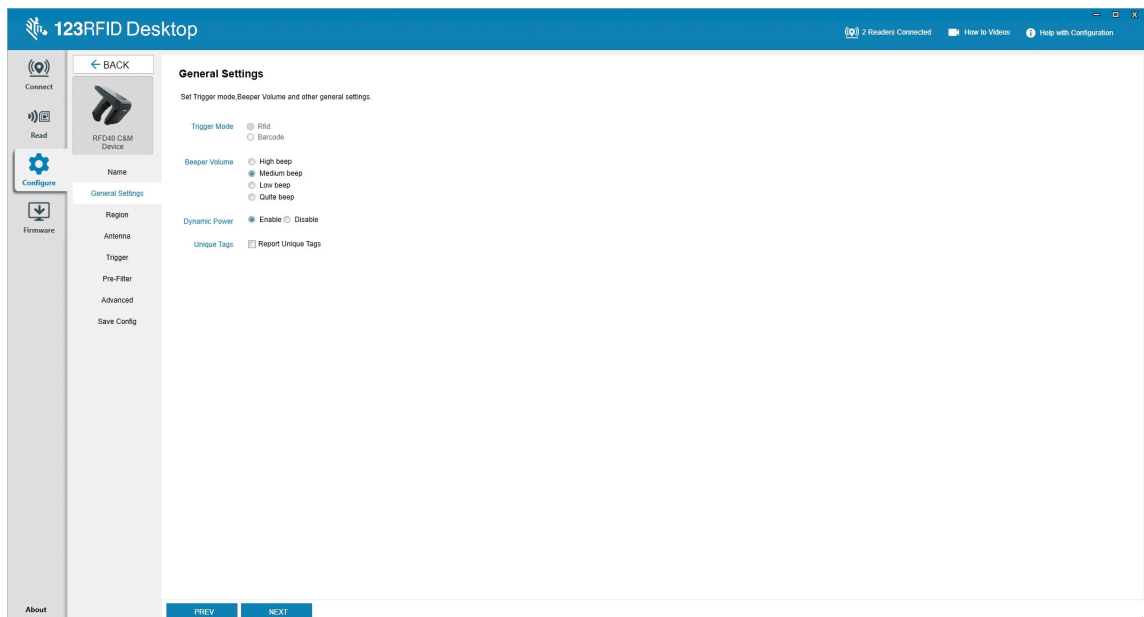

Region Configuration

To set up the region in which the reader will be used, select the Region of Operation from the drop down menu. Next, select the appropriate channels by clicking the associated check boxes.

Ensure that the reader is configured for the correct region that it will be used in. Configuring the device for a different region is illegal.

Figure 40 Region Configuration

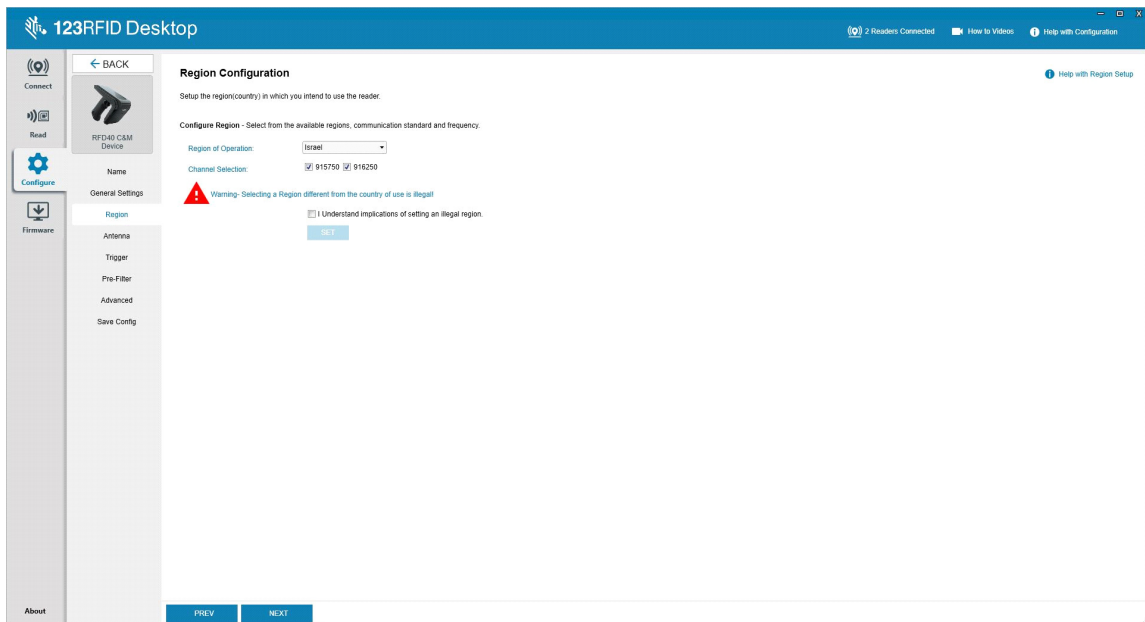

Antenna Configuration

Configure the name and color of the antenna, enable or disable Select for Reads, adjust the power (dBm), and enable different RF modes using Antenna Port Settings.

Figure 41 Antenna Port Configuration

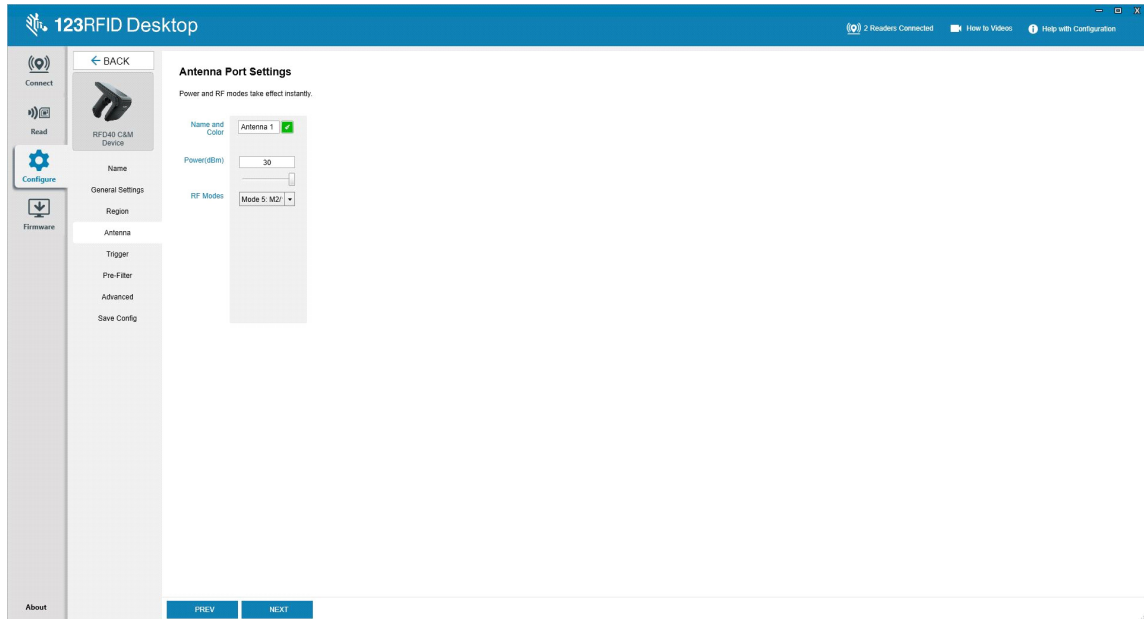

Trigger Configuration

Triggers that indicate to the device to start reading tags can be configured to occur during specific events such as what Start is pressed, when the handheld trigger is pressed, or after a specified duration (ms).

Triggers that indicate to the device to stop reading tags can be configured to occur after specific events such as when Stop is pressed, a specified amount of tag reads, a specified duration of time (ms), a specific number of inventory rounds complete, or when the handheld trigger is released.

Figure 42 Trigger Settings Configuration

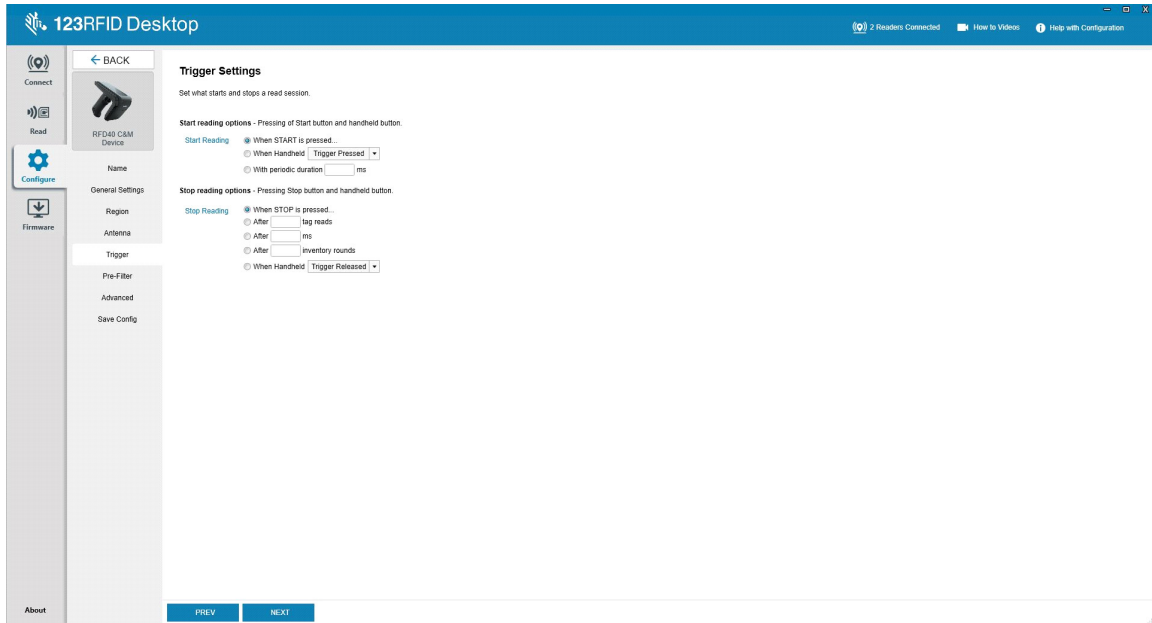

Pre-Filter Configuration

Configure pre-filters by first enabling the filter by clicking the checkbox. Next, enter the data into the tag pattern field, select the target, memory, and action from the associated dropdown menus. Last, enter the offset into the form field and click Next.

Figure 43 Pre-Filter Configuration

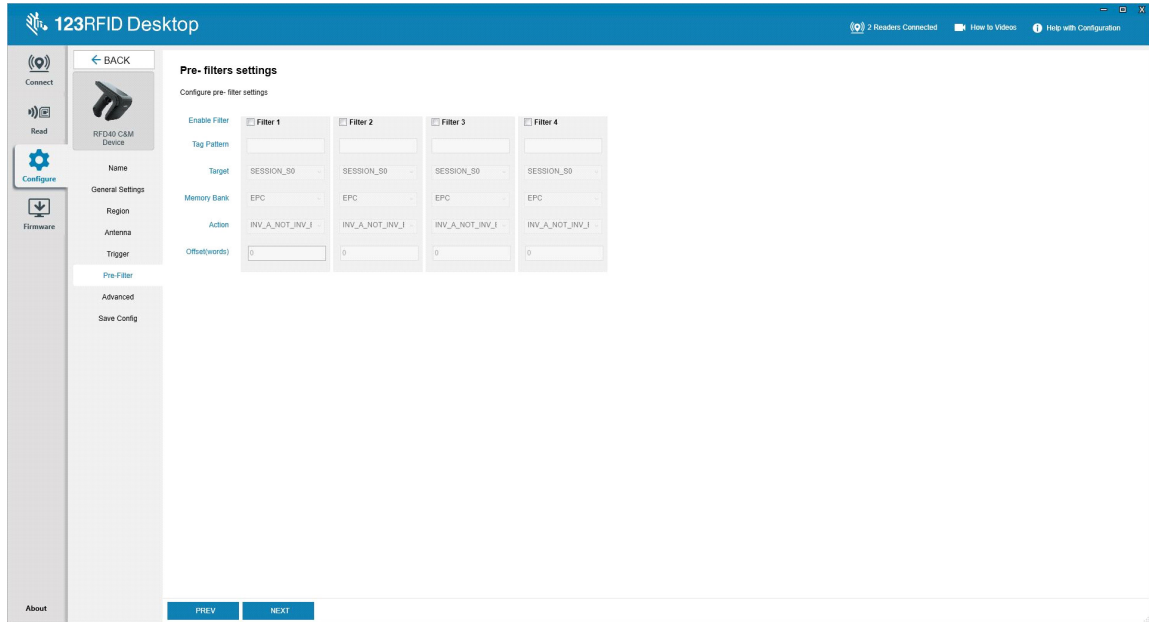

Advanced Configuration Settings

Enable Editing of Advanced Settings, then choose antenna singulation from the dropdown menu, select State Aware options, and determine the Tag Population Estimate. Click Sync to save the changes and complete the configuration workflow.

Figure 44 Advanced Configuration Settings

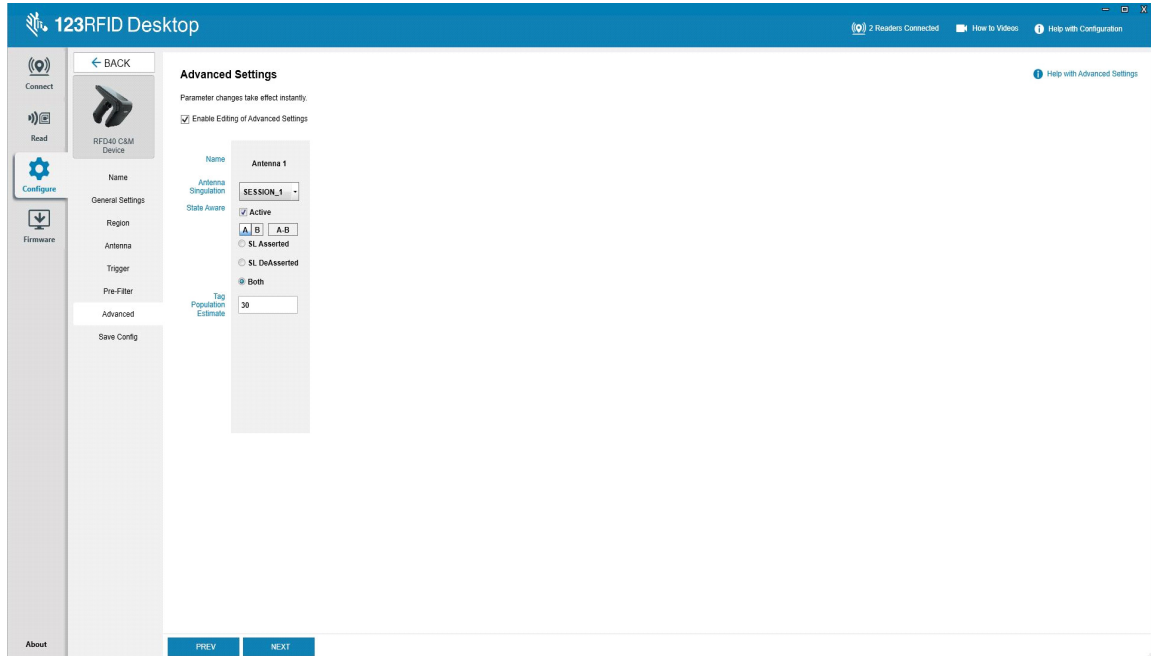

Save and Print Configuration

Save the configuration file to the PC, push the antenna settings to the reader, or reset the antenna settings to factory defaults at the end of the configuration workflow.

Figure 45 Save Configuration

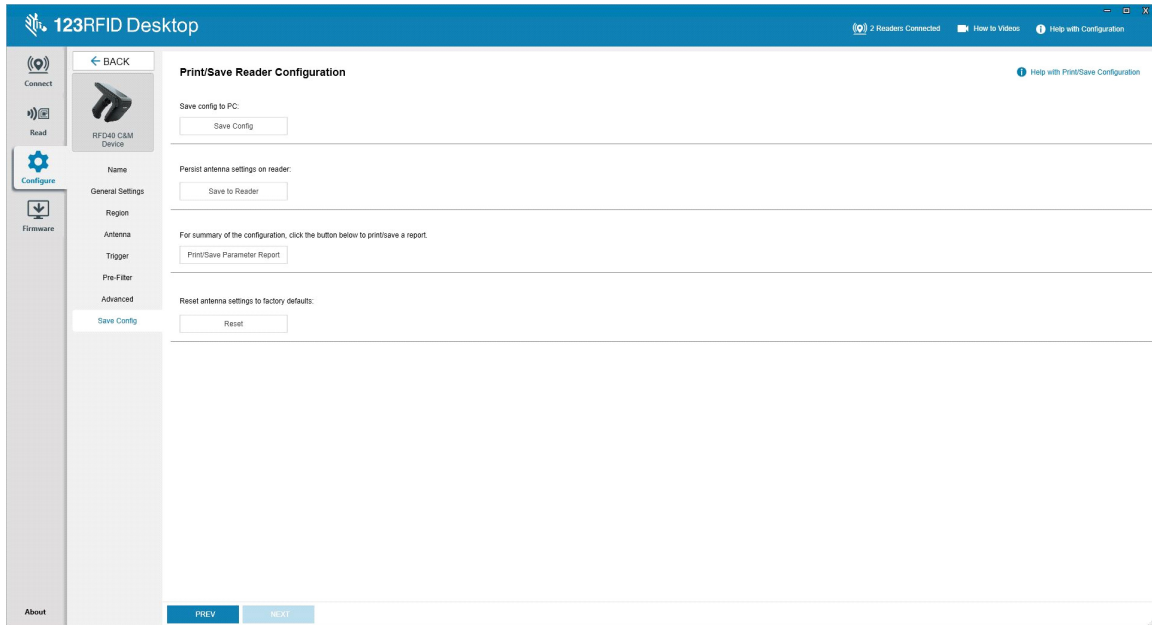

Firmware Management

To update reader firmware on up to five devices simultaneously, select the devices on the table by clicking the associated checkbox and click the **Update Firmware** button.

Figure 46 Select Devices to Update

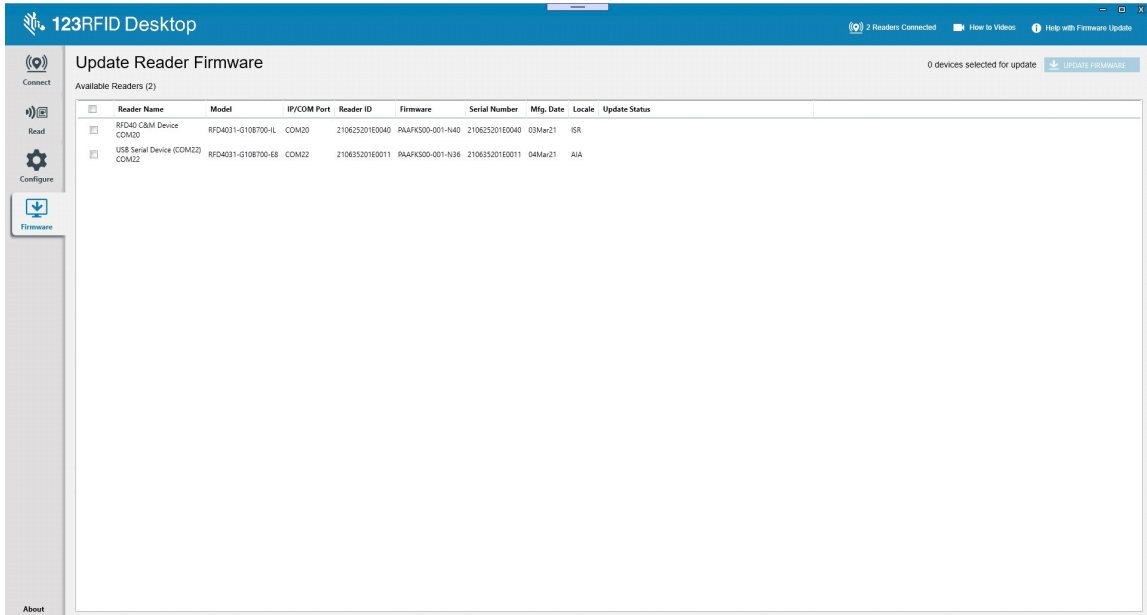

Next, the Reader Firmware Update window displays. Click Browse to select the firmware version to be enabled onto the selected device.

Figure 47 Select a Firmware Update

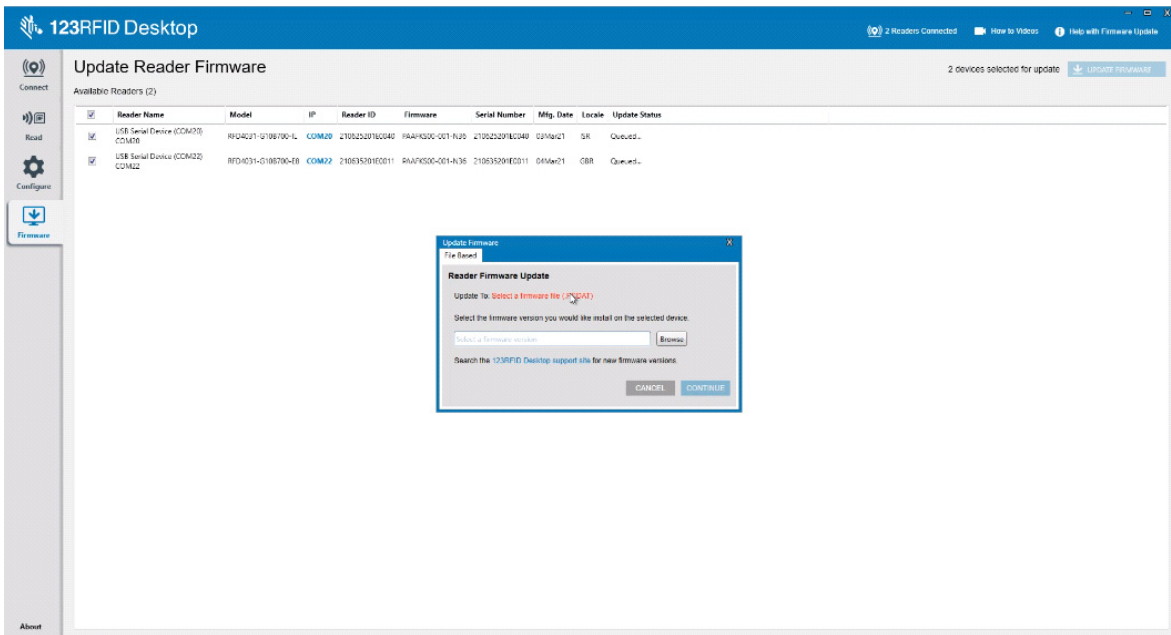

Once the firmware file is selected, the update starts and the progress bars next to the associated readers indicate the completion percentage of the update.

Figure 48 Firmware Update Progress

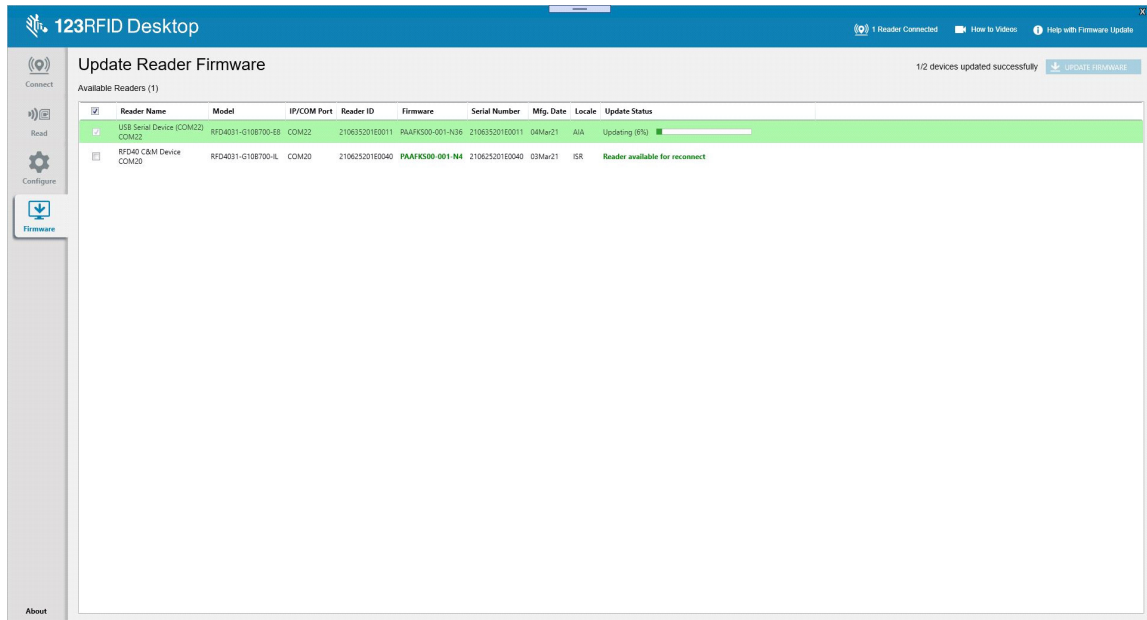

Maintenance and Technical Specifications

This chapter provides suggested sled maintenance, troubleshooting, and technical specifications.



CAUTION: Always wear eye protection.

Read warning label on compressed air and alcohol product before using.

If you have to use any other solution for medical reasons please contact Zebra for more information.



WARNING: Avoid exposing this product to contact with hot oil or other flammable liquids. If such exposure occurs, unplug the device and clean the product immediately in accordance with these guidelines.

Maintenance



IMPORTANT Use pre-moistened wipes and do not allow liquid cleaner to pool.

¹ Ensure the following items are addressed when using sodium hypochlorite (bleach) based cleaners:

- For device only. Do not use on cradle.
- Always follow the manufacturer's recommended instructions: use gloves during application and remove the residue afterwards with a damp cloth to avoid prolonged skin contact while handling the device.
- Due to the powerful oxidizing nature of sodium hypochlorite, the metal surfaces, including electrical contacts on the device, are prone to oxidation (corrosion) when exposed to this chemical in the liquid form (including wipes) and should be avoided. In the event that these type of disinfectants come in contact with metal on the device, prompt removal with a dampened cloth after the cleaning step is critical.



IMPORTANT To avoid damage to the device, use only approved cleaning and disinfecting agents listed below. The use of non-approved cleaning or disinfecting agents may void the warranty.

Known Harmful Ingredients

The following chemicals are known to damage the plastics on Zebra devices and should not come in contact with the device:

- Acetone
- Ammonia solutions
- Aqueous or alcoholic alkaline solutions
- Aromatic and chlorinated hydrocarbons
- Benzene
- Carbolic acid

- Compounds of amines or ammonia
- Ethanolamine
- Ethers
- Ketones
- TB-lysoform
- Toluene
- Trichloroethylene.

Approved Cleaners

- Isopropyl alcohol 70% (including wipes)
- 10% Bleach (Sodium Hypochlorite 0.55%) and 90% Water solution
- 3% Hydrogen Peroxide and 97% Water solution
- Mild dish soap.

Cleaning the Sled

Routinely cleaning the exit window is required. A dirty window may affect scanning accuracy. Do not allow any abrasive material to touch the window.

To clean the device:

1. Dampen a soft cloth with one of the approved cleaning agents listed above or use pre-moistened wipes.
2. Gently wipe all surfaces, including the front, back, sides, top and bottom. Never apply liquid directly to the device. Be careful not to let liquid pool around the device window, trigger, cable connector or any other area on the device.
3. Be sure to clean the trigger and in between the trigger and the housing (use a cotton-tipped applicator to reach tight or inaccessible areas).
4. Do not spray water or other cleaning liquids directly into the exit window.
5. Wipe the device exit window with a lens tissue or other material suitable for cleaning optical material such as eyeglasses.
6. Immediately dry the device window after cleaning with a soft non-abrasive cloth to prevent streaking.
7. Allow the unit to air dry before use.
8. Connectors:
 - a. Dip the cotton portion of a cotton-tipped applicator in isopropyl alcohol.
 - b. Rub the cotton portion of the cotton-tipped applicator back-and-forth across the connector on the Zebra sled at least 3 times. Do not leave any cotton residue on the connector.
 - c. Use the cotton-tipped applicator dipped in alcohol to remove any grease and dirt near the connector area.
 - d. Use a dry cotton tipped applicator and rub the cotton portion of the cotton-tipped applicator back-and-forth across the connectors at least 3 times. Do not leave any cotton residue on the connectors.

Technical Specifications

Table 11 RFD40 RFID Standard Sled Technical Specifications

Item	Description
Physical Characteristics	
Dimensions	Height: 15.6 cm (5.94 in.) Width: 8.4 cm (3.3 in.) Length: 16.6 cm (6.5 in.)
Weight	~19.1 oz./~541 grams (sled with battery)
Power	PowerPrecision+ 7000 mAh Li-Ion battery
Frequency Range/ RF Output	US: 902-928 MHz; 0 - 30 dBm (EIRP) EU: 865-868 MHz; 0 - 30 dBm (EIRP) Japan: 916-921 MHz (w LBT); 0 - 30 dBm (EIRP)
User Environment	
Operating Temperature	-10°C to 50°C (14°F to 122°F)
Storage Temperature	-40°C to 70°C (-40°F to 158°F)
Charging Temperature	0°C to 40°C (32°F to 104°F)
Relative Humidity	Operating: 5 to 85% non-condensing
Sealing	IP54
Drop Specification	Multiple 5 ft./1.8 m drops onto concrete
Tumble Specification	500 1/2 meter tumble cycles (1000 drops) at 20°C
Electrostatic Discharge (ESD)	± 15 kV air discharge ± 8 kV direct discharge ± 8 kV indirect discharge

Troubleshooting

Troubleshooting

Table 12 Troubleshooting the RFD40 RFID Standard Sled

Symptom	Possible Cause	Action
The RFID sled does not read tags.	The RF region configuration is not set.	Use the 123RFID Desktop or 123RFID Mobile application to set the regulatory region or country operation per the application instructions.
RFID sled is attached to mobile device and it is not responsive to a RFID application, even after the trigger is pressed.	Battery is too low and not able to power the RFID sled.	Press the trigger for a couple of seconds to power the RFID sled On. The RFID sled LED blinks amber when it is turned On. (By default, pressing the trigger turns On the RFID sled if it is in Off mode. However, the RFID sled can be disabled in which case this step is not necessary.) Place the RFID sled in the charging cradle. The RFID sled blinks amber LEDs indicating charging commenced.
	Zebra supported mobile computer is not properly inserted in the RFID Sled.	Reinsert the Zebra supported mobile device securely in the RFID sled and ensure that the USB cable is correctly inserted.
	Damaged battery.	If the RFD40 RFID sled LED does not blink amber after sitting on charging cradle for a while, request service to replace battery.
RFID sled is responsive but cannot read tags.	Battery is critically low.	Place the RFID sled in the charging cradle. The RFID Sled LED blinks amber. The RFID sled can be used when its LED turns on momentarily amber or green upon removal from charging cradle.
The RFD40 RFID sled LED blinks fast amber when in the cradle.	Charging error.	Restart charging by removing the RFID sled from the cradle and inserting it back in the cradle. If issue persists, request service to replace battery.

Table 12 Troubleshooting the RFD40 RFID Standard Sled

Symptom	Possible Cause	Action
RFID sled LED blinks red, or LED blinks red alternating with green or amber while in use (not while charging).	Battery end of life indication.	Request service to replace battery.
Zebra supported mobile computer battery is not charging.	Charging cradle was unplugged from AC power.	Ensure the charging cradle is receiving power.
	The Zebra supported mobile computer is not fully seated in the cradle.	Remove and re-insert the zebra supported mobile computer into the cradle, ensuring it is firmly seated in the charging cradle.

